

ZX16-IP/ZX16-IP-SOi

Image Projector . ZX16 Series



Product Features

- Small image projector using GOBO, color filter or colorizer for outdoor or indoor application.
- ETL outdoor wet location listed. IP65 standard.
- Machined from solid billet 6061-T6 corrosion resistant aluminum.
- 240° vertical and 360° horizontal adjustment via unique swivel stem design.
- US patented integral SORAA® heat sink.

Integral SORAA® Heat Sink: US patented Thermobuster™ provides extra heat dissipation that reduces the lamp junction temperature by 77°F(25°C). Enables even the highest wattage SORAA® lamps to be used in an enclosed fixture without sacrificing its performance or life expectancy.

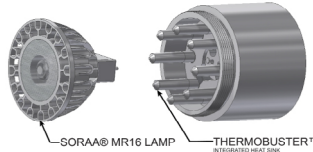

Specification

Materials: Machined from billet 6061-T6 corrosion resistant aluminum with 304 stainless steel hardware. Available in 304/316 stainless steel or 360 brass upon request.

Glare Shield: 3 optional glare shields(GSL-long, GSA-angled GSS-short) for additional glare control. See page 3 for details.

Light Source: MR16 Halogen lamp or MR16 SORAA® LED lamp. Please refer to [SORAA MR16 GU5-3](#) for lamp selection.

Voltage: 12V AC/DC. Requires remote step down transformer.

Wattage: Max. 9W for SORAA MR16 lamp with Thermobuster. Max. 50W for halogen MR16 without Thermobuster.

Lamp Base/Socket: Standard bi-pin socket for GU5.3/G4/GX5.3/GY6.35/GZ4.

Dimmability: MLV or ELV. Please refer to website for SORAA® MR16 dimmer compatibility. [SORAA MR16 dimmer compatibility](#).

Finish: Polyester powder coat on all aluminum materials with RoHS compliant procedures. Anodized finish is available. Stainless steel and brass models are provided with brushed surface.

Optical Accessories: Accepts combinations of accessories (including colorizer, color filters, steel gobo etc.). Secured in place with metal snap ring.

Mounting Method: Mounts using 1/2"-14 NPS male fitting compatible with all HK Lighting Group mounting devices.

GOBO Size: See data on second page.

Ordering Guide

EXAMPLE: ZX16-IP-SOi - CGSL - 12V - 00917 - BK -GOBO - MH02

ZX16-IP - CGSL - 12V - 0 - BK -GOBO - MH02

SERIES	MATERIAL	OPTIONAL GLARE SHIELD	VOLTAGE	OPTIONAL LAMP	FINISH	OPTIC ACCESSORIES	OPTIONAL MOUNTING ACCESSORIES
ZX16-IP HALOGEN	BLANK Aluminum(Standard) NBR Natural Brass NSS Natural Stainless Steel CU Natural Copper	CGSL CGSA CGSS	12V	0-NONE XXXXX SORAA® LAMP CODE (5 DIGIT SORAA CAT. NO*)	Standard BK Black Powder Coat BZ Bronze Powder Coat WT White Powder Coat Premium ABK Anodized Black ACL Anodized Clear CC Custom Powder Coat	GOBO CR Colorizer CF Color Filter	See page 2 for quick reference, or "Accessories" link for detailed specification.
ZX16-IP-SOi SORAA®							

*SORAA® Lamp Selection: [SORAA MR16 GU5-3](#)

Remote Step Down Transformer (Optional).
See "[Accessories](#)" link for detailed specification.

Model	Wattage(VA)	Primary Voltage(VAC)	Secondary Volt(VAC)	Dimming Method	Characters
TXM	20 40 60 100 150 300	120 or 277	12	MLV	Outdoor, Wall Mount, Compact
TXS	150 300 600	120	Multi-tap of 12, 13, 14, 15 VAC	MLV	Outdoor, Wall mount, Stainless Steel Case
IGT	50(120V only) 100 300 600	120 or 277	12	MLV	in grade
TXE	60	120, 230, or 277	12	ELV	Needs Enclosure, 6ft working distance

Product Drawings

NOTE: Specification and dimensions subject to change without notice.

ZX16-IP-SOi

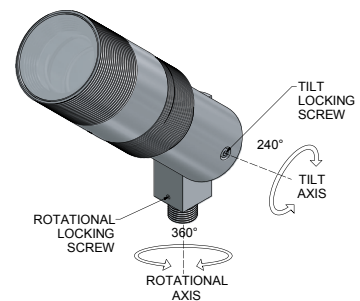
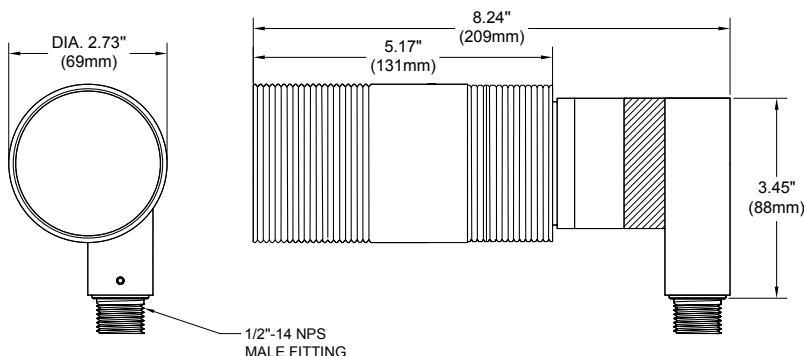

Photometry & Energy Data

All SORAA® MR16 GU5.3 base lamps can be used in this fixture.
Please refer to SORAA® website: [SORAA MR16 GU5-3](http://www.soraa.com/SORAA-MR16-GU5-3)

Cone Of Image

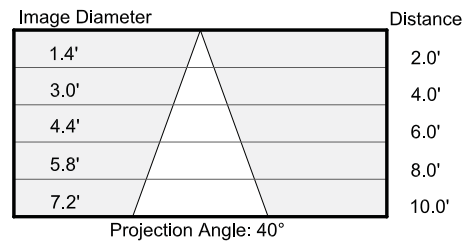

Typical Data

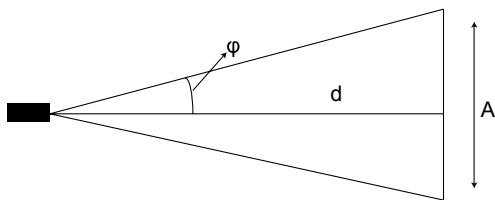

$\tan \phi = 0.5 A / d$
 d = distance between fixture and projection plan
 A = diameter if the projected image
 2ϕ = projection angle

Image Projector Size	Projection angle	GOBO size in mm (OD/IA)	Watt	Input Volt
ZXL08	28°	20/13(Rosco 518)	3	12 Vac
ZXL11	28°	27.5/22(Rosco Mac500/918)	5	12 Vac
ZXL16/16i	40°	36.3/31(Rosco Studio Spot 575)	5,7, 10	12 Vac/ Line Volt
ZX16/16i-SOi	40°	36.3/31(Rosco Studio Spot 575)	7.5, 9	12 Vac/ Line Volt
ZXL18i	40°	36.3/31(Rosco Studio Spot 575)	19	Line Volt
ZXL20i	50°	53.3/38(Rosco size D)	21, 28	Line Volt
ZXL30i	50°	100/75(Rosco size A)	41	Line Volt
ZXL38i	50°	100/75(Rosco size A)	52	Line Volt

Note: Data may vary due to different focal length of lens or IA of GOBO.

Product Options & Accessories

Optional Glare Shield

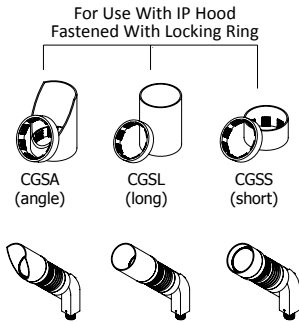

Mounting Accessories

Canopy Plate:

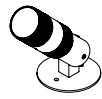

Fixture On CM5

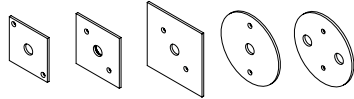

CM2 CM1 CM3 CM5 CM5-2

Surface Mount Box:

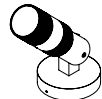

Fixture On CB5.1

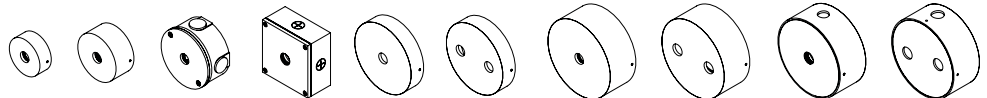

CMLJ CB3.5 CB4.0 CB4.0-SQ CB5.1 CB5.1-2 CB5.5 CB5.5-2 CB5.5-K/O CB5.5-K/O-2

Ground Mount:

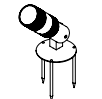

Fixture On MH02

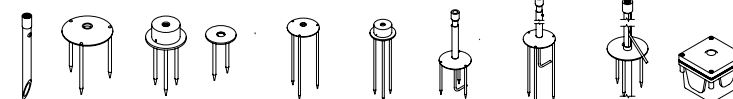

MHCS MH02 MH2-T MH05 MH2-12 MH2-T-12 MHVL6-12 MHVL12-24 MH01



JB1

Tree Mount:

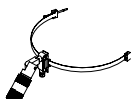

Fixture On TM120-TS

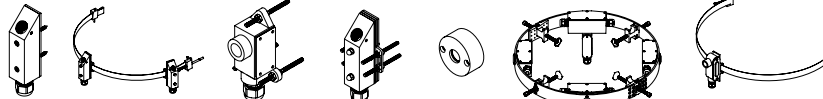

TM125 TM125-TS-2 TM120-C-SM-HB TM125-HB TMR2 TS-SO TM120-TS

Extension:

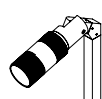

Fixture With EX,EL

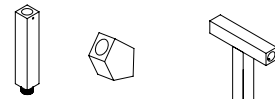

EX EL T-BAR

Sign Light Arm:

Please See The Sign Light Section

Notes