

ZXL16-CAT

LED Catenary · ZX16 Series



Product Features

- A unique catenary system including fixtures, turnbuckle, suspension cable, power cable for outdoor or indoor illumination.
- ETL outdoor wet location listed. IP65 standard.
- Machined from solid billet 6061-T6 corrosion resistant aluminum.
- Modular components - field changeable LED module & beam spread reflectors.

Specification

Materials: Machined from billet 6061-T6 corrosion resistant aluminum with 304 stainless steel hardware. Available in 304/316 stainless steel or 360 brass upon request.

Glare Shield: 3 optional glare shields(GSL-Long, GSA-angled GSS-short) for additional glare control. See page 3 for details.

Fixture Weight: 1lb.

Voltage: 12V AC/DC. Requires remote step down transformer.

Wattage: 5, 7 or 10W HK LED.

Dimmability: MLV.

Light Source: CRI 83. Available in CRI95 upon request. The chromaticity range is within a 3-step McAdam Ellipse. Standard CCT options are 2700K, 3000K, 4000K.

Lamp Base / Socket: Innovative cone-shaped lamp base and receptacle socket maximize the surface contact area to dissipate heat more effectively. See "Resources" for details.

Finish: Polyester powder coat on all aluminum materials with RoHS compliant procedures. Anodized finish is available. Stainless steel and brass models are provided with brushed surface.

Optical Accessories: Accepts up to 3 accessories (hexcel louver, optical lenses, dichroic color filters, etc.). Secured in place with metal snap ring.

Mounting Method: Custom hook mechanism on top of fixture that utilizes set screws to secure fixture(s) on the suspension cable and to lock the position of fixture on the cable.

Turn Buckle (Optional): Allows fine tuning of the tension on the support cable, up to 1.50" of adjustment.

Power Cable (Optional): 18/2 SJTW cable, dia 0.29".

Suspension Cable (Optional): 7x7 stainless steel wire rope, maximum diameter is 5/32", capacity 450lbs.

Ordering Guide

EXAMPLE: ZXL16-CAT - GSL - 12V - 7 - 27 - 20 - BK - DF - TURN BUCKLE

SERIES	MATERIAL	OPTIONAL GLARE SHIELD	VOLTAGE	WATTAGE	CCT	OPTICS	FINISH	OPTIONAL SELECT UP TO 3 OPTIC ACCESSORIES	OPTIONAL MOUNTING ACCESSORIES
ZXL16-CAT			12V						
	BLANK Aluminum(Standard)	GSL		5 5W	27 2700K	20 20°	Standard	LVR Hexcel Louver	See page 3 for quick reference, or "Accessories" link for detailed specification.
	NBR Natural Brass	GSA		7 7W	30 3000K	33 33°	BK Black Powder Coat	OSL Overall Spread Lens	
	NSS Natural Stainless Steel	GSS		10 10W	40 4000K	44 44°	BZ Bronze Powder Coat	LSL Linear Spread Lens	
	CU Natural Copper					57 57°	WT White Powder Coat	SOL Solite Soft Focus	
							Premium ABK Anodized Black ACL Anodized Clear CC Custom Powder Coat	DF Dichroic Filter	

Remote Step Down Transformer for 12V fixture(Optional). See "Accessories" link for detailed specification.

Model	Wattage(VA)	Primary Voltage(VAC)	Secondary Volt(VAC)	Dimming Method	Characters
TXM	20 40 60 100	120 or 277	12	MLV	Outdoor, Wall Mount, Compact
TXS	150	120	Multi-tap of 12, 13, 14, 15 VAC	MLV	Outdoor, Wall mount, Stainless Steel Case
IGT	50(120V only) 100	120 or 277	12	MLV	in grade

Product Drawings

NOTE: Specification and dimensions subject to change without notice.

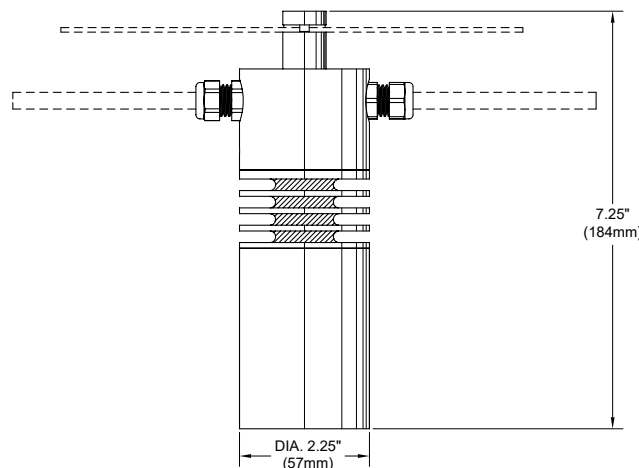

Photometry & Energy Data
MODEL ZXL16-CAT-10W-N

Input Power	9.5W
Color Temperature (CCT)	3000K
Color Rendering Index (Ra)	83
Beam Angle	20.5°
Max. Candelpower	3507cd
Delivered Lumens	864lm
Efficacy	91lm/W

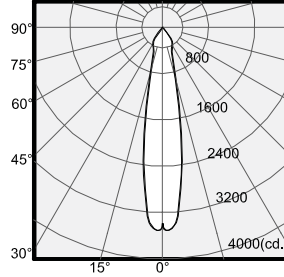
Polar Graph - Intensity

Cone of Light - Illuminance

Center Beam (fc)	Beam Diameter	Distance
877	0.7'	2.0'
219	1.4'	4.0'
97	2.2'	6.0'
55	2.9'	8.0'
35	3.6'	10.0'

1/2 Beam Angle: 20.5°

MODEL ZXL16-CAT-10W-M

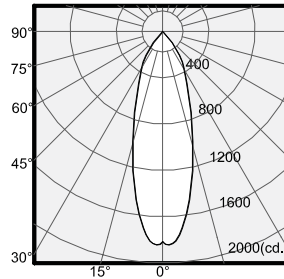
Input Power	9.5W
Color Temperature (CCT)	3000K
Color Rendering Index (Ra)	83
Beam Angle	32.5°
Max. Candelpower	1842cd
Delivered Lumen	863lm
Efficacy	91lm/W

Polar Graph - Intensity

Cone of Light - Illuminance

Center Beam (fc)	Beam Diameter	Distance
460	1.2'	2.0'
115	2.3'	4.0'
51	3.5'	6.0'
29	4.6'	8.0'
18	5.8'	10.0'

1/2 Beam Angle: 32.5°

MODEL ZXL16-CAT-10W-W

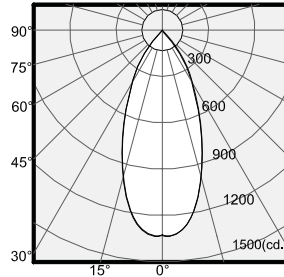
Input Power	9.5W
Color Temperature (CCT)	3000K
Color Rendering Index (Ra)	83
Beam Angle	44.1°
Max. Candelpower	1332cd
Delivered Lumen	850lm
Efficacy	89lm/W

Polar Graph - Intensity

Cone of Light - Illuminance

Center Beam (fc)	Beam Diameter	Distance
333	1.6'	2.0'
83	3.2'	4.0'
37	4.9'	6.0'
21	6.5'	8.0'
13	8.1'	10.0'

1/2 Beam Angle: 44.1°

MODEL ZXL16-CAT-10W-VW

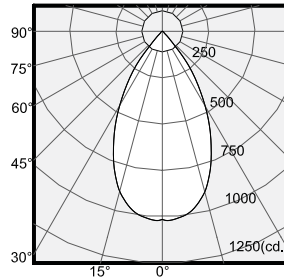
Input Power	9.5W
Color Temperature (CCT)	3000K
Color Rendering Index (Ra)	83
Beam Angle	56.9°
Max. Candelpower	1019cd
Delivered Lumen	876lm
Efficacy	92lm/W

Polar Graph - Intensity

Cone of Light - Illuminance

Center Beam (fc)	Beam Diameter	Distance
255	2.3'	2.0'
64	4.6'	4.0'
28	6.9'	6.0'
16	9.2'	8.0'
10	11.5'	10.0'

1/2 Beam Angle: 56.9°

Wattage Multiplier Table

Wattage	Multiplier
5Watt	0.53
7Watt	0.77
10Watt	1.00

CCT Multiplier Table

Color Temp.	Multiplier
2700k	0.97
3000k	1.00
4000k	1.05

Product Options & Accessories

Optional Glare Shield

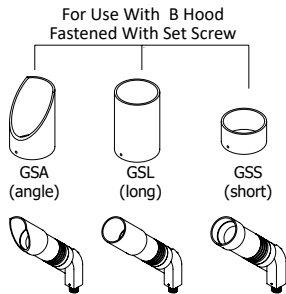

Mounting Accessories

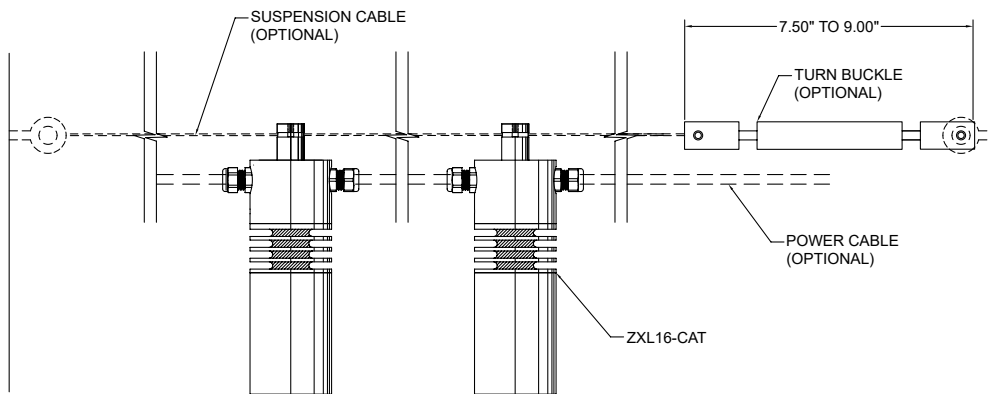

Suspension Cable:

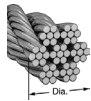

Power Cable:



Turn Buckle:

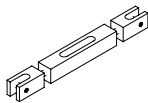

Notes