

ZX16 Center Pivot GU10



(includes former ZX16-CPV-GU10-SOi model)

ACCENT & LANDSCAPE | ZX16 Series | 2.25"

7.5W (600LM) | 120, 230V | SORAA, LED Lamp, Halogen

FEATURES

- Versatile round, directional 120V/230V MR16 (GU10) traditional Center Pivot accent light for residential and commercial environments.
- Flexible lamp configurations include SORAA LED Lamp with patented Heat Sink or use your preferred LED or Halogen lamp.
- Wet Location Listed, IP67 Standard.
- Machined from solid aircraft grade (6061-T6), corrosion-resistant aluminum, then anodized and powder coated to create a highly durable, marine grade finish.
- 240° vertical and 360° horizontal adjustment via locking swivel stem design.
- Field changeable optical lensing available.
- Available with adjustable Angled, Long, and Short Glare Shields and ground, surface, and canopy mounting options.
- Every fixture tested end of line for water tightness and light quality.
- Ships complete with selected accessories installed.



Center Pivot Line Voltage GU10 Accent: ZX16-1C1SA-AAC

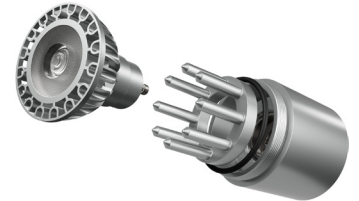

Integral SORAA® Heat Sink

US patented Thermobuster™ provides extra heat dissipation that reduces the lamp junction temperature by 77°F(25°C). Enables even the highest wattage SORAA® lamps to be used in an enclosed fixture without sacrificing its performance or life expectancy.

SPECIFICATIONS

Materials

Solid billet 6061-T6 corrosion resistant aluminum with 304 stainless steel hardware.

Finish

Aluminum materials are first anodized and then powder coated for a robust, marine grade finish. Stainless steel and brass models are provided with brushed surface.

Hood and Glare Shield

Weeping and Non-weeping Hood Styles. Set screw or threaded Angled, Short, or Long Glare Shields. (See page 4 for details).

Voltage

120 or 230V AC.

Wattage

Max. 9W for SORAA MR16 lamp with Thermobuster. Max. 50W for halogen MR16 without Thermobuster.

Light Engine

MR16 GU10 Halogen lamp or MR16 GU10 SORAA® LED lamp. Please refer to [SORAA MR16 GU10](#) for lamp selection.

Dimming

MLV, ELV Phase Control Dimming at 120V. Please refer to website for [SORAA® GU10 dimmer compatibility](#).

Lamp Base/Socket

Porcelain GU10 twist - lock lamp base.

Optics

Accepts up to 3 accessories (hexcel louver, optical lenses, dichroic color filters, etc.). Secured in place with metal snap ring.

Mounting

Mounts using 1/2"-14 NPS male fitting compatible with all HK Lighting Group mounting devices.

Listings

ETL Listed for Wet Location, IP67 Standard. RoHS Compliant.

ORDERING GUIDE

EXAMPLE: ZX16-1C1SA-ABL-120VSL-08750-GSA-LVR-MHJB-06-BRZ

| MODEL | PHYSICAL OPTIONS | | | MATERIAL / FINISH | | | LIGHT ENGINE | | | | | |
|---|------------------|--|--------------|-------------------|----------|----------------------------|----------------|--------------------------------------|-------------|---------------------|-----------|--------------------------------------|
| ZX16 ZX16 Series 2.25" Accent Light SORAA LED, LED Lamp or Halogen Lamp Line Voltage (GU10) | 1C1 | | S | | | | | | | | | |
| | TYPE | | STYLE | HOOD | | | VOLTAGE | | | | | |
| | 1C1 | Line Voltage, Center Pivot Accent ¹ | S | Standard | A | A Style: Weeping | ABL | Aluminum Black | 120V | 120V AC (GU10 Lamp) | NL | No Lamp ² |
| | | | | | B | B Style: No Weep Holes | ABR | Aluminum Bronze | 230V | 230V AC (GU10 Lamp) | SL | SORAA Lamp Included ³ |
| | | | | | C | C Style: Threaded, Weeping | AWH | Aluminum White | | | SN | SORAA Lamp Not Included ³ |
| | | | | | | | AAC | Aluminum Anodized Clear ¹ | | | CC | Custom Lamp Included |
| | | | | | | | NBR | Natural Brass ¹ | | | | |
| | | | | | | | NCU | Natural Copper ¹ | | | | |
| | | | | | | | NSS | Natural Stainless Steel ¹ | | | | |
| | | | | | | | CCC | Custom Finish ¹ | | | | |

¹ Consult factory for specialty finish quoting and lead times

² Compatible with Halogen Lamp

³ Only compatible with SORAA LED Lamp

⁴ 120V Only

OPTIONAL INSTALLED ACCESSORIES

| SORAA LAMP | | GLARE SHIELD | | OPTIC | | MOUNTING (Most common listed, see Page 4 for additional options) | |
|--------------|--------------------------------------|--------------|-------------------------|------------|---------------------|--|--|
| XXXXX | SORAA LED Lamp Code | GSA | A/B Glare Shield Angled | LVR | Hexcel Louver | GROUND MOUNT | |
| 08750 | SORAA Brilliant HL 7.5W ⁴ | GSL | A/B Glare Shield Long | OSL | Overall Spread Lens | MHJB-06-BRZ | 6" Stainless Steel 3-Prong Spike (120-277V) Bronze |
| | | GSS | A/B Glare Shield Short | LSL | Linear Spread Lens | MHJB-12-BRZ | 12" Stainless Steel 3-Prong Spike (120-277V) Bronze |
| | | CGSA | C Glare Shield Angled | SOL | Solite Soft Focus | JB-1 | Brass In-ground Junction Box |
| | | CGSL | C Glare Shield Long | DCF | Dichroic Filter | CANOPY MOUNT | |
| | | CGSS | C Glare Shield Short | | | CM1-XXX | 3.75" Square Canopy Plate |
| | | | | | | CM3-XXX | 4.75" Square Canopy Plate |
| | | | | | | CM5-XXX | 5" Round Canopy Plate |
| | | | | | | CM5-2-XXX | 5" Round Canopy Plate - Double |
| | | | | | | SURFACE MOUNT | |
| | | | | | | CB4.0-XXX | 4" Round Surface Box |
| | | | | | | CB5.5-XXX | 5.5" Round Surface Box |
| | | | | | | TREE MOUNT | |
| | | | | | | TM07-JBS-XXX | Single Aluminum Tree Mount Box with Stainless Steel Strap (120V) |
| | | | | | | TM07-JBT-XXX | Twin Aluminum Tree Mount Box with Stainless Steel Strap (120V) |
| | | | | | | EXTENSIONS | |
| | | | | | | EX-12-XXX | 12" Extension |
| | | | | | | EX-24-XXX | 24" Extension |
| | | | | | | EL-XXX | Elbow Extension |

• Consult Accessory Spec Sheet for desired option code.

• XXX represents color option.

ADDITIONAL ACCESSORIES (Not installed at time of order)

GLARE SHIELD ACCESSORIES

| | |
|--------------------|-------------------------|
| GSL-16-XXX | A/B Glare Shield Long |
| GSA-16-XXX | A/B Glare Shield Angled |
| GSS-16-XXX | A/B Glare Shield Short |
| CGSL-16-XXX | C Glare Shield Long |
| CGSA-16-XXX | C Glare Shield Angled |
| CGSS-16-XXX | C Glare Shield Short |

OPTIC ACCESSORIES

| | |
|---------------|---------------------|
| LVR-16 | Hexcel Louver |
| OSL-16 | Overall Spread Lens |
| LSL-16 | Linear Spread Lens |
| SOL-16 | Solite Soft Focus |
| DCF-16 | Dichroic Filter |

PRODUCT DRAWINGS

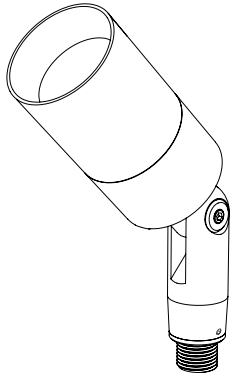

ZX16-1C1SB

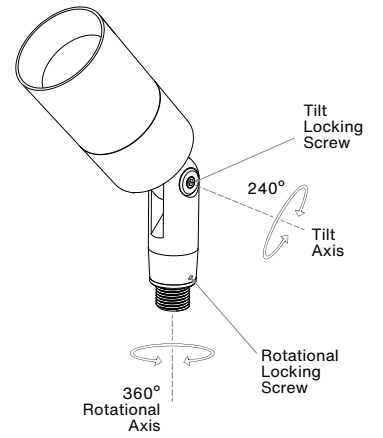
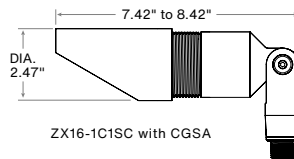
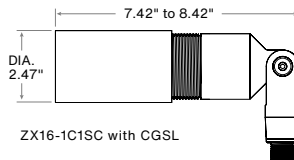
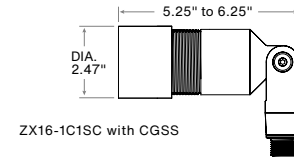
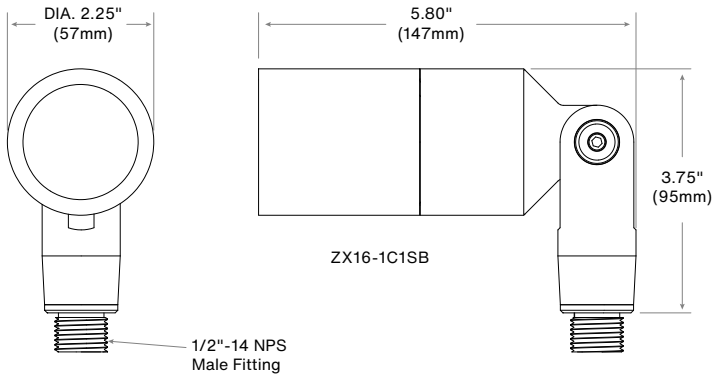

OPTIONS & ACCESSORIES

HOOD OPTIONS

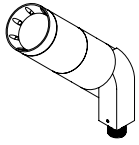

A-HOOD
Versatile hood with 8 weep holes for water drainage. Regressed lens for glare control. Suggested for general use or when fixture is aimed in an up position.

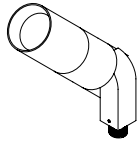

B-HOOD
Similar to A hood but without weep holes. Regressed lens for glare control. Used in an interior or down light application.

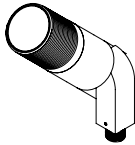

C-HOOD
Flush hood with machined threading on the outside for attachment of C-style glare shield, cleverly designed with hidden drainage channels.

OPTIONAL GLARE SHIELD

For use with A & B Hood, fastened with Set Screw



For use with C Hood fastened with Locking Ring



MOUNTING ACCESSORIES

Canopy Mount:

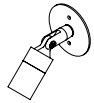

Fixture On CM5

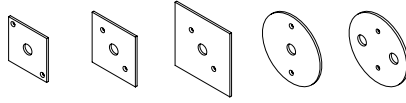

CM2 CM1 CM3 CM5 CM5-2

Surface Mount Box:

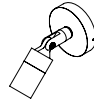

Fixture On CB5.1

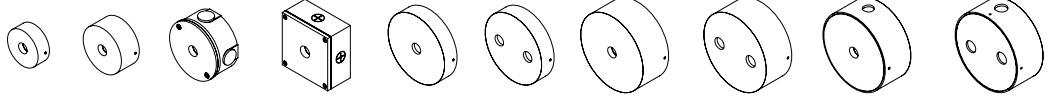

CMLJ CB3.5 CB4.0 CB4.0-SQ CB5.1 CB5.1-2 CB5.5 CB5.5-2 CB5.5-K/O CB5.5-K/O-2

Ground Mount:



Fixture On MHJB-06

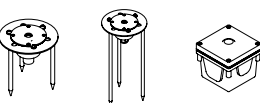

MHJB-06 MHJB-12 JB-1

Tree Mount:

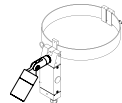

Fixture On TM07-JBS

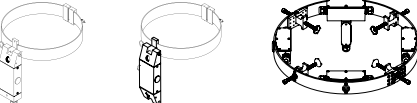

TM07-JBS TM07-JBT TS-SO

Extension:

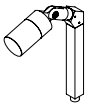

Fixture With EX,EL



EX EL ET

Sign Light Arm: Please reference the Sign & Pole Mounting section in [Accessories](#) on our website.

Notes: