

ZX16 Center Pivot

(includes former ZX16-CPV and ZX16-CPV-SOi models)

ACCENT & LANDSCAPE | ZX16 Series | 2.25"
7.5W (640lm) | 12V | SORAA, LED Lamp, Halogen

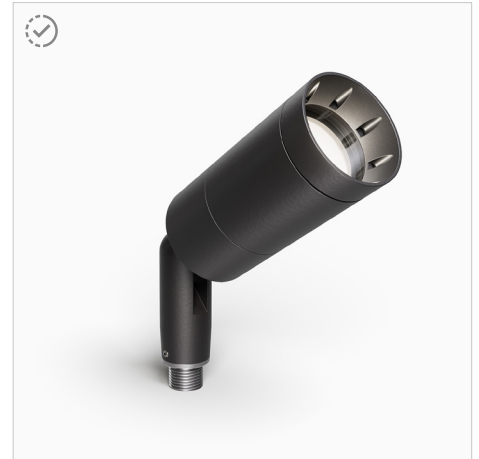

SORAA LED Center Pivot Accent: ZX16-0C1SA-ABL

FEATURES

- Versatile round, directional MR16 (GU 5.3) traditional Center Pivot accent light for architectural outdoor and landscape lighting environments.
- Flexible lamp configurations include SORAA LED Lamp with patented Heat Sink or use your preferred LED or Halogen lamp.
- Wet Location Listed, IP67 Standard.
- Machined from solid aircraft grade (6061-T6), corrosion-resistant aluminum, then anodized and powder coated to create a highly durable, marine grade finish. Also available in solid brass or stainless steel.
- 240° vertical and 360° horizontal adjustment via locking swivel stem design.
- Field changeable optical lensing available.
- Available with adjustable Angled, Long, and Short Glare Shields and ground, surface, and canopy mounting options.
- Every fixture tested end of line for water tightness and light quality.
- Readymade eligible configurations ship in 2 to 4 weeks, complete with selected accessories installed.

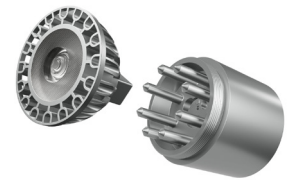

Integral SORAA® Heat Sink

US patented Thermobuster™ provides extra heat dissipation that reduces the lamp junction temperature by 77°F(25°C). Enables even the highest wattage SORAA® lamps to be used in an enclosed fixture without sacrificing its performance or life expectancy.

SPECIFICATIONS

Materials

Machined from billet 6061-T6 corrosion resistant aluminum with 304 stainless steel hardware. Available in 304/316 stainless steel or 360 brass upon request.

Finish

Aluminum materials are first anodized and then powder coated for a robust, marine grade finish. Stainless steel and brass models are provided with brushed surface.

Hood and Glare Shield

Weeping and Non-weeping Hood Styles. Set screw or threaded Angled, Short, or Long Glare Shields. (See page 4 for details).

Voltage

12V AC/DC. Requires remote step down transformer.

Wattage

Max. 9W for SORAA MR16 lamp with Thermobuster. Max. 50W for Halogen lamp.

Light Engine

MR16 Halogen lamp or MR16 SORAA LED lamp. Please refer to [SORAA MR16 GU5.3](#) lamp selection.

Dimming

MLV, ELV Phase Control dimming. Please refer to website for [SORAA MR16](#) dimmer compatibility.

Lamp Base/Socket

Standard bi-pin socket for GU5.3/G4/GX5.3/GY6.35/GZ4.

Optics

Accepts up to 3 accessory pieces (hexcel louver, optical lenses, dichroic color filters, etc.). Secured in place with metal snap ring.

Mounting

Mounts using 1/2"-14 NPS male fitting compatible with all HK Lighting mounting accessories (See page 4 for details).

Listings

ETL Listed for Wet Location, IP67 Standard. RoHS Compliant.

ORDERING GUIDE

EXAMPLE: ZX16-0C1SA-ABL-012VSL-08728-GSA-LVR-MHCS-06

MODEL	PHYSICAL OPTIONS			MATERIAL / FINISH		LIGHT ENGINE		
ZX16 ZX16 Series 2.25" Accent Light SORAA LED, LED Lamp or Halogen Lamp Low Voltage (GU5.3)	OC1 TYPE OC1 Low Voltage, Center Pivot Accent ¹	S STYLE S Standard	HOOD		ABL Aluminum Black ABR Aluminum Bronze AWH Aluminum White AAC Aluminum Anodized Clear ¹ NBR Natural Brass ¹ NCU Natural Copper ¹ NSS Natural Stainless Steel ¹ CCC Custom Finish ¹	012V VOLTAGE 012V 12V AC (GU5.3 Lamp)	LAMP	
			A A Style: Weeping B B Style: No Weep Holes C C Style: Threaded, Weeping	NL No Lamp ² SL SORAA Lamp Included ³ SN SORAA Lamp Not Included ³ CC Custom Lamp Included				

- Readymade eligible configurations ship in 2 to 4 weeks
- ¹ Consult factory for specialty finish quoting and lead times
- ² Compatible with Halogen Lamp
- ³ Only compatible with SORRA LED Lamp

OPTIONAL INSTALLED ACCESSORIES

SORAA LAMP		GLARE SHIELD		OPTIC		MOUNTING (Most common listed, see Page 4 for additional options)	
XXXX	SORAA LED Lamp Code	GSA	A/B Glare Shield Angled	LVR	Hexcel Louver	GROUND MOUNT	
08728	SORAA Brilliant HL 7.5W	GSL	A/B Glare Shield Long	OSL	Overall Spread Lens	MHCS-06	6" PVC Single Prong Spike (12V)
		GSS	A/B Glare Shield Short	LSL	Linear Spread Lens	MHCS-12	12" PVC Single Prong Spike (12V)
		CGSA	C Glare Shield Angled	SOL	Solite Soft Focus	MH02-06-BRZ	6" Stainless Steel 3-Prong Spike (12V) Bronze
		CGSL	C Glare Shield Long	DCF	Dichroic Filter	MH02-12-BRZ	12" Stainless Steel 3-Prong Spike (12V) Bronze
		CGSS	C Glare Shield Short			JB-1	Brass In-ground Junction Box

ADDITIONAL ACCESSORIES (Not installed at time of order)

GLARE SHIELD ACCESSORIES		OPTIC ACCESSORIES	
GSL-16-XXX	A/B Glare Shield Long	LVR-16	Hexcel Louver
GSA-16-XXX	A/B Glare Shield Angled	OSL-16	Overall Spread Lens
GSS-16-XXX	A/B Glare Shield Short	LSL-16	Linear Spread Lens
CGSL-16-XXX	C Glare Shield Long	SOL-16	Solite Soft Focus
CGSA-16-XXX	C Glare Shield Angled	DCF-16	Dichroic Filter
CGSS-16-XXX	C Glare Shield Short		

CANOPY MOUNT	
CM1-XXX	3.75" Square Canopy Plate
CM3-XXX	4.75" Square Canopy Plate
CM5-XXX	5" Round Canopy Plate
CM5-2-XXX	5" Round Canopy Plate - Double
SURFACE MOUNT	
CMLJ-XXX	2.7" Round Surface Box
CB4.0-XXX	4" Round Surface Box
CB5.5-XXX	5.5" Round Surface Box
TREE MOUNT	
TM120C-ABR	Aluminum Tree Mount Box (120V)
TM120-TS-ABR	Stainless Steel Strap for TM120
EXTENSIONS	
EX-RD-12-XXX	12" Round Extension
EX-RD-24-XXX	24" Round Extension

- Consult Accessory Spec Sheet for desired option code.
- XXX represents color option.
- Readymade options available in ABL and ABR only unless noted by the part code above.

OUTDOOR MAGNETIC TRANSFORMERS (120V input/12VAC Output)

TRANSFORMERS (Go to [Accessories](#) for detailed specification)

EXAMPLE: TXS-150-SS

MODEL		WATTAGE (VA)						PRIMARY VOLTAGE (VAC)	
TXM	Stainless steel, wet location outdoor magnetic transformer Multitap 12VAC Output MLV Dimming	300						OTR-SS (120V Only)	
TXS	Stainless steel, wet location outdoor magnetic transformer Multitap 12VAC Output MLV Dimming	150	300	600				SS (120V Only)	
TXM	Compact, damp location magnetic transformer 12VAC Output MLV Dimming	20	40	60	100	150	300	120	277
IGT	In ground outdoor magnetic transformer 12VAC Output MLV Dimming	50 (120V Only)			100	300	600	120	277
TXE	In-fixture or near mounted electronic transformer 12VAC Output ELV Dimming Enclosure by others	60						120	277

PRODUCT DRAWINGS

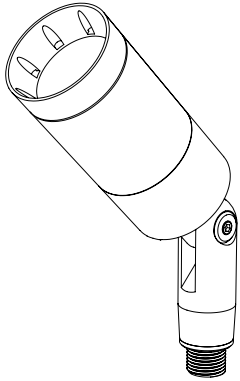

ZX16-0C1SA
Center Pivot

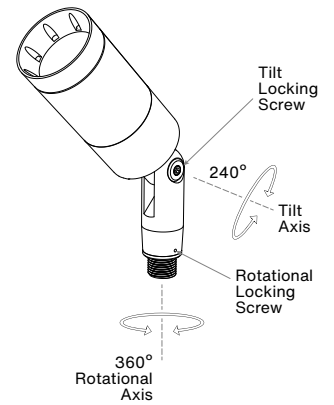
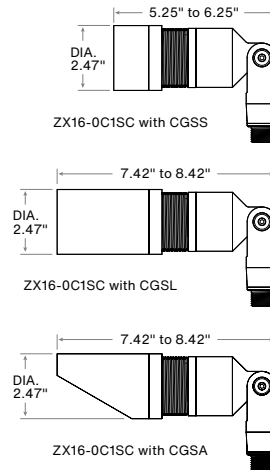
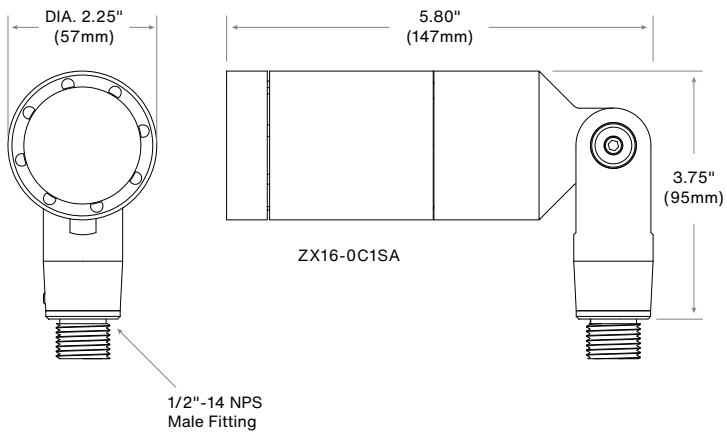

OPTIONS & ACCESSORIES

HOOD OPTIONS

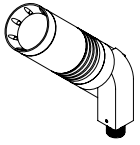

A HOOD

Versatile hood with 8 weep holes for water drainage. Regressed lens for glare control. Suggested for general use or when fixture is aimed in an up position.

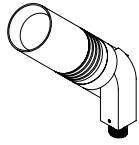

B HOOD

Similar to A hood but without weep holes. Regressed lens for glare control. Suggested for downlighting and interior applications.

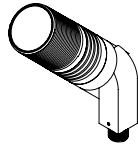

C HOOD

Designed for permanent use with a glare shield and innovative drainage design for water and debris. The machined threads enable ongoing glare shield adjustment, without impact to the paint surface.

OPTIONAL GLARE SHIELD

For use with A & B Hood, fastened with Set Screw



GSA
(angle)



GSL
(long)



GSS
(short)



For use with C Hood fastened with Locking Ring



CGSA
(angle)



CGSL
(long)

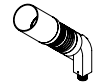

CGSS
(short)



MOUNTING ACCESSORIES

Canopy Mount:

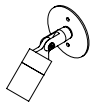

Fixture On CM5



CM1



CM3



CM5



CM5-2



CM2

Surface Mount Box:

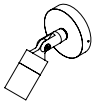

Fixture On CB5.1



CMLJ



CB4.0



CB5.5



CB3.5



CB4.0-SQ



CB5.1



CB5.1-2



CB5.5-2



CB5.5-2K



CB5.5-2-2K

Ground Mount:

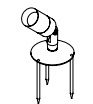

Fixture On MH02

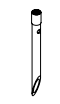

MHCS



MH02-06



MH02-12



JB-1



MH02-T-06



MH05



MH02-T-12



MHVL-06-12



MHVL-12-24



MH01

Tree Mount:

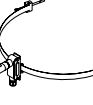

Fixture On TM120-TS



TM120C



TM120-TS



TM120-C-SM-HB



TM125

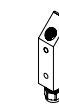

TM125-TS-2



TM125-HB



TMR2



TS-SO

Extension:

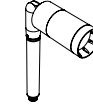

Fixture With EX-RD



EX-RD

Sign Light Arm: Please reference the Sign & Pole Mounting section in [Accessories](#) on our website.

Readymade eligible configurations ship in 2 to 4 weeks.

Notes: