

# ZX16 Square

(includes former ZX16-SQ and ZX16-SQ-SOi model)



ACCENT & LANDSCAPE | ZX16 Series | 2.25"  
7.5W (640lm) | 12V | SORAA, LED Lamp, Halogen

## FEATURES

- Versatile square, directional MR16 (GU5.3) modern accent light for most architectural outdoor and landscape lighting environments. Ideal for highlighting trees, palms, plantings, or architectural elements where lamp choice and long-term serviceability are important.
- Flexible lamp configurations include SORAA® LED Lamp with patented Heat Sink or use your preferred MR16 (GU5.3) LED or halogen lamp.
- Wet Location Listed, IP67 Standard.
- Machined from solid aircraft grade (6061-T6), corrosion-resistant aluminum, then anodized and powder coated to create a highly durable, marine-grade finish. Also available in solid brass or stainless steel.
- 90° vertical and 360° horizontal adjustment via locking swivel stem design.
- Field changeable optical lensing available.
- Available with adjustable Angled, Long, and Short Glare Shields and ground, surface, and canopy mounting options.
- Every fixture tested end of line for water tightness and light quality.
- Ships complete with selected accessories installed.



SORAA LED Square Accent: ZX16-0S1SA-NBR

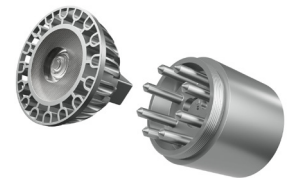

### Integral SORAA Heat Sink

US patented Thermobuster™ provides extra heat dissipation that reduces the lamp junction temperature by 77°F(25°C). Enables even the highest wattage SORAA® lamps to be used in an enclosed fixture without sacrificing its performance or life expectancy.

## SPECIFICATIONS

<p><b>Materials</b> Machined from solid billet 6061-T6 corrosion-resistant aluminum with 304 stainless steel hardware. Available in 316 stainless steel or 360 brass upon request.</p> <p><b>Finish</b> Aluminum materials are anodized and then powder coated for a robust, marine-grade finish. Stainless steel and brass models are provided with brushed surface.</p> <p><b>Hood and Glare Shield</b> Weeping Hood Style with Angled, Short, or Long Glare Shields. (See page 4 for details)</p>	<p><b>Voltage</b> 12V AC/DC. Requires remote step down transformer.</p> <p><b>Wattage</b> Max 9W for SORAA MR16 lamp with Thermobuster. Max 50W for halogen lamp.</p> <p><b>Light Engine</b> MR16 Halogen or MR16 SORAA LED lamp. Compatible with SORAA Brilliant HL and other MR16 GU5.3 lamp selections. (See Ordering Guide for available lamp options and specifications.)</p> <p><b>Dimming</b> MLV, ELV Phase Control dimming. Please refer to website for <a href="#">SORAA MR16</a> dimmer compatibility.</p>	<p><b>Lamp Base/Socket</b> Standard bi-pin socket for GU5.3/G4/GX5.3/GY6.35/GZ4.</p> <p><b>Optics</b> Provided SORAA Lamp delivers 10. beam spread. Select optional SORAA Snap System Beam Spreader magnetic lenses to expand optical beam up to 60. Accepts up to 3 accessory pieces (hexcel louver, optical lenses, etc.). Secured in place with metal snap ring. (See Ordering Guide for available SORAA lamp options.)</p> <p><b>Mounting</b> Mounts using a 1/2"-14 NPS male fitting compatible with all HK Lighting mounting accessories.</p> <p><b>Listings</b> ETL Listed for Wet Location, IP67 Standard. RoHS Compliant.</p>
--	---	--

## ORDERING GUIDE

EXAMPLE: ZX16-0S1SA-ABL-012VSL-08728-GSA-LVR-MHCS-06

MODEL	PHYSICAL OPTIONS			MATERIAL / FINISH	LIGHT ENGINE	
<b>ZX16</b> ZX16 Series 2.25" Accent Light SORAA LED, LED Lamp or Halogen Lamp Low Voltage (GU5.3)	<b>OS1</b>	<b>S</b>	<b>A</b>		<b>012V</b>	
	<b>TYPE</b> OS1 Low Voltage, Square Accent	<b>STYLE</b> S Standard	<b>HOOD</b> A A Style: Weeping	<b>ABL</b> Aluminum Black <b>ABR</b> Aluminum Bronze <b>AWH</b> Aluminum White <b>AAC</b> Aluminum Anodized Clear <sup>1</sup> <b>NBR</b> Natural Brass <sup>1</sup> <b>NCU</b> Natural Copper <sup>1</sup> <b>NSS</b> Natural Stainless Steel <sup>1</sup> <b>CCC</b> Custom Finish <sup>1</sup>	<b>VOLTAGE</b> 012V 12V AC (GU5.3 Lamp)	<b>LAMP</b> <b>NL</b> No Lamp <sup>2</sup> <b>SL</b> SORAA Lamp Included <sup>3</sup> <b>SN</b> SORAA Lamp Not Included <sup>3</sup> <b>CC</b> Custom Lamp Included

<sup>1</sup> Consult factory for specialty finish quoting and lead times  
<sup>2</sup> Compatible with Halogen Lamp  
<sup>3</sup> Only compatible with SORAA LED Lamp

## OPTIONAL INSTALLED ACCESSORIES

SORAA LAMP		GLARE SHIELD		OPTIC		MOUNTING (Most common listed, see Page 4 for additional options)	
XXXXX	SORAA LED Lamp Code	GSA	A Hood Glare Shield Angled	LVR	Hexcel Louver	<b>GROUND MOUNT</b>	
08722	SORAA Brilliant HL (7.5W, 10°, 2700K) Included <sup>3</sup>	GSL	A Hood Glare Shield Long	OSL	Overall Spread Lens	MHCS-06	6" PVC Single Prong Spike (12V)
08728	SORAA Brilliant HL (7.5W, 10°, 3000K) Included <sup>3</sup>	GSS	A Hood Glare Shield Short	LSL	Linear Spread Lens	MHCS-12	12" PVC Single Prong Spike (12V)
				SOL	Solite Soft Focus	JB-1	Brass In-ground Junction Box
				DCF	Dichroic Filter	<b>CANOPY MOUNT</b>	
						CM1-XXX	3.75" Square Canopy Plate
						CM3-XXX	4.75" Square Canopy Plate
						CM5-XXX	5" Round Canopy Plate
						CM5-2-XXX	5" Round Canopy Plate - Double
						<b>SURFACE MOUNT</b>	
						CMLJ-XXX	2.7" Round Surface Box
						CB4.0-XXX	4" Round Surface Box
						CB5.5-XXX	5.5" Round Surface Box
						<b>TREE MOUNT</b>	
						TM125-ABR	Aluminum Tree Mount Box (12V)
						TM125-TS-ABR	Stainless Steel Strap for TM125

<sup>4</sup> Use SORAA Snap System Beam Spreader lenses to expand optical beams up to 60°

- Consult Accessory Spec Sheet for desired option code.
- XXX represents color option

## ADDITIONAL ACCESSORIES (Not installed at time of order)

GLARE SHIELD ACCESSORIES		OPTIC ACCESSORIES		SORAA LAMP		SORAA SNAP SYSTEM BEAM SPREADER	
GSL-16-XXX	A Hood Glare Shield Long	LVR-16	Hexcel Louver	SL-08722	SORAA Brilliant HL (7.5W, 10°, 2700K) <sup>4</sup>	ALASO-SNAP17-03263	SORAA SNAP 17° Beam Spreader
GSA-16-XXX	A Hood Glare Shield Angled	OSL-16	Overall Spread Lens	SL-08728	SORAA Brilliant HL (7.5W, 10°, 3000K) <sup>4</sup>	ALASO-SNAP25-00325	SORAA SNAP 25° Beam Spreader
GSS-16-XXX	A Hood Glare Shield Short	LSL-16	Linear Spread Lens			ALASO-SNAP36-00327	SORAA SNAP 36° Beam Spreader
		SOL-16	Solite Soft Focus			ALASO-SNAP60-00329	SORAA SNAP 60° Beam Spreader
		DCF-16	Dichroic Filter				

## OUTDOOR MAGNETIC TRANSFORMERS (120V input/12VAC Output)

TRANSFORMERS (Go to [Accessories](#) for detailed specification)

EXAMPLE: TXS-150-SS

MODEL		WATTAGE (VA)				PRIMARY VOLTAGE (VAC)	
TXM	Stainless steel, wet location outdoor magnetic transformer Multitap   12-15VAC Output   MLV Dimming	150	300			OTR-SS (120V Only)	
TXS	Stainless steel, wet location outdoor magnetic transformer Multitap   12VAC Output   MLV Dimming	150	300	600		SS (120V Only)	
TXM	Compact, damp location magnetic transformer 12VAC Output   MLV Dimming	20	40	60	100	120	
IGT	In ground outdoor magnetic transformer 12VAC Output   MLV Dimming	50 (120V Only)		100	300	120	277
TXE	In-fixture or near mounted electronic transformer 12VAC Output   ELV Dimming   Enclosure by others	60				120	277

**PRODUCT DRAWINGS**

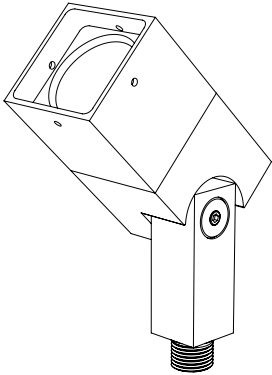

**ZX16-0S1SA**

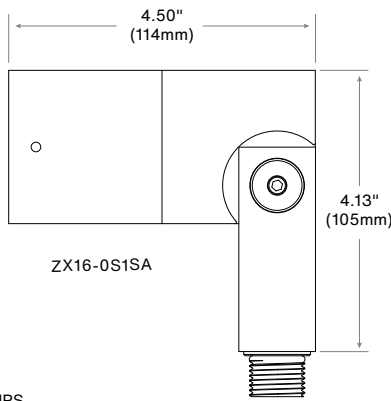
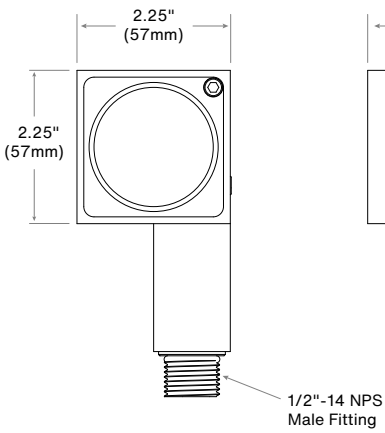

**ZX16-0S1SA**

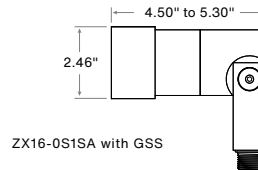

ZX16-0S1SA with GSS

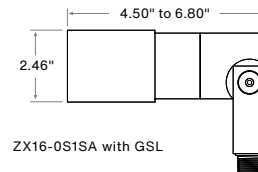

ZX16-0S1SA with GSL

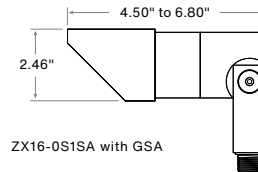

ZX16-0S1SA with GSA

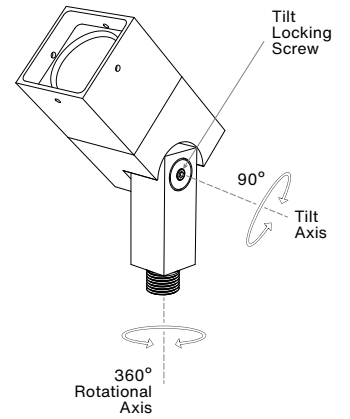

## OPTIONS & ACCESSORIES

### OPTIONAL GLARE SHIELD

For use with Square Hood,  
fastened with Set Screw

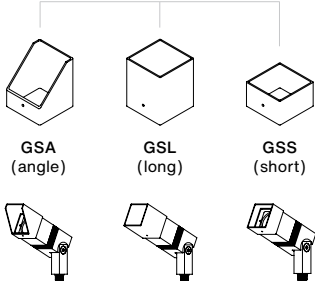

GSA  
(angle)

GSL  
(long)

GSS  
(short)

### MOUNTING ACCESSORIES

#### Canopy Mount:

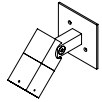

Fixture On CM3



CM2



CM1



CM3



CM5



CM5-2

#### Surface Mount Box:

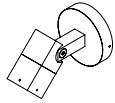

Fixture On CB5.1



CMLJ



CB3.5



CB4.0

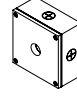

CB4.0-SQ



CB5.1

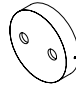

CB5.1-2

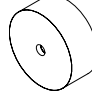

CB5.5

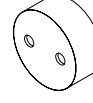

CB5.5-2

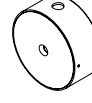

CB5.5-K/O

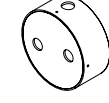

CB5.5-K/O-2

#### Ground Mount:



Fixture On MHJB-6



MHJB-6

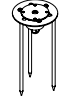

MHJB-12

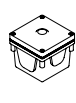

JB-1

#### Tree Mount:

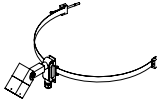

Fixture On TM120-TS

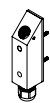

TM125

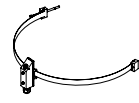

TM125-TS

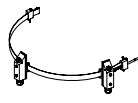

TM125-TS-2

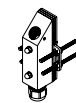

TM125-HB

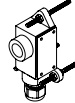

TM120-C-SM-HB

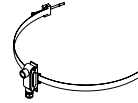

TM120-TS

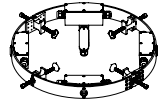

TS-SO

#### Extension:

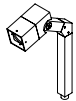

Fixture With EX, EL



EX



EL

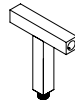

ET

**Sign Light Arm:** Please reference the Sign & Pole Mounting section in [Accessories](#) on our website.

#### Notes: