

ZXL11 Square

(includes former ZXL11-SQ & ZXL11-SQ-NF models)

ACCENT & LANDSCAPE | ZX11 Series | 1.57"
5 - 7W (450 - 675lm) | 12V | HK LED, RGB, Amber



IP67

FEATURES

- Compact yet powerful square, directional 12V LED modern accent light for most architectural outdoor and landscape lighting environments.
- 5W, 7W integrated HK LED delivering 450 to 675 lumens. 2200-4000K CCT, including specialty Amber and RGB options.
- Wet Location Listed, IP67 Standard.
- Machined from solid aircraft grade (6061-T6), corrosion-resistant aluminum, then anodized and powder coated to create a highly durable, marine grade finish. Also available in solid brass or stainless steel.
- 180° vertical and 360° horizontal adjustment via locking swivel stem design.
- Modular components, field changeable LED optical beams, and lenses.
- Available with adjustable Angled, Long, and Short Glare Shields and ground, surface, and canopy mounting options.
- Every fixture tested end of line for water tightness and light quality.
- Ships complete with selected accessories installed.



Standard Low Voltage Square Accent: ZXL11-0S1S-AAC



Finned Low Voltage Square Accent: ZXL11-0S1FA-ABR

SPECIFICATIONS

Materials

Machined from billet 6061-T6 corrosion resistant aluminum with 304 stainless steel hardware. Available in 304/316 stainless steel or 360 brass upon request.

Finish

Aluminum materials are first anodized and then powder coated for a robust, marine grade finish. Stainless steel and brass models are provided with brushed surface.

Hood and Glare Shield

Weeping Hood Style with Angled, Short, or Long Glare Shields. (See page 4 for details)

Voltage

12V AC/DC. Requires remote step down transformer.

Wattage

5, 7W HK LED delivers 450 to 675 lumens.

Light Engine

Innovative HK LED Light module operates like a lamp and can be easily changed in the field. CRI 90 Standard. Available in CRI 80 or CRI 95 upon request. Standard CCT options are 2700K, 3000K, 3500K, 4000K. Specialty 2200K, 2400K, 2500K, Amber, and RGB options available. Consult factory for specialty LED specification details.

Dimming

MLV or ELV Phase Control dimming.

Optics

Narrow (29°), Medium (40°), Wide (57°) beam spread options available. Accepts up to 3 optical accessories (hexcel louver, optical lenses, dichroic color filters, etc.) Secured place with metal snap ring.

Mounting

Mounts using 1/2"-14 NPS male fitting compatible with all HK Lighting Group mounting devices. (See page 4 for details)

ORDERING GUIDE

EXAMPLE: ZXL11-0S1SA-ABL-012V05W-27N-GSA-SQ-LVR-MHCS-06

MODEL	OPTIONS			MATERIAL / FINISH		POWER		LIGHT	
ZXL11	OS1					012V			
ZX11 Series 1.57" Accent Light Integrated HK LED	TYPE	STYLE	HOOD	ABL Aluminum Black		VOLTAGE	WATTAGE	CCT	OPTICS
	OS1 Low Voltage, Square Accent	S Standard F Finned	A A Style: Weeping	ABR Aluminum Bronze		012V 12V AC	05W 5 Watts (450lm) 07W 7 Watts (675lm) SPW Specialty ²	22 2200K 24 2400K 25 2500K 27 2700K 30 3000K 35 3500K 40 4000K AM Amber ² RG RGB ²	N Narrow (29°) M Medium (40°) W Wide (57°) CC Custom Optic
				AWH Aluminum White					
				AAC Aluminum Anodized Clear ¹					
				NBR Natural Brass ¹					
				NCU Natural Copper ¹					
				NSS Natural Stainless Steel ¹					
				CCC Custom Finish ¹					

¹ Consult factory for specialty finish quoting and lead times

² For Specialty AM (AMBER LED) and RG (RGB LED),
Choose SPW (Specialty) for Wattage. Consult factory for
RGB compatibility before specification or order.

OPTIONAL INSTALLED ACCESSORIES

GLARE SHIELD

GSA-SQ	Square Glare Shield Angled
GSL-SQ	Square Glare Shield Long
GSS-SQ	Square Glare Shield Short

OPTIC

LVR	Hexcel Louver
OSL	Overall Spread Lens
LSL	Linear Spread Lens
SOL	Solite Soft Focus
DCF	Dichroic Filter

MOUNTING (Most common listed, see Page 4 for additional options)

GROUND MOUNT	
MHCS-06	6" PVC Single Prong Spike (12V)
MHCS-12	12" PVC Single Prong Spike (12V)
MH02-06-BRZ	6" Stainless Steel 3-Prong Spike (12V) Bronze
MH02-12-BRZ	12" Stainless Steel 3-Prong Spike (12V) Bronze
JB-1	Brass In-ground Junction Box
CANOPY MOUNT	
CM1-XXX	3.75" Square Canopy Plate
CM3-XXX	4.75" Square Canopy Plate
CM5-XXX	5" Round Canopy Plate
CM5-2-XXX	5" Round Canopy Plate - Double
SURFACE MOUNT	
CMLJ-XXX	2.7" Round Surface Box
CB4.0-XXX	4" Round Surface Box
CB5.5-XXX	5.5" Round Surface Box
TREE MOUNT	
TM125-ABR	Aluminum Tree Mount Box (12V)
TM125-TS-ABR	Stainless Steel Strap for TM125
EXTENSIONS	
EX-12-XXX	12" Extension
EX-24-XXX	24" Extension
EL-XXX	Elbow Extension

ADDITIONAL ACCESSORIES (Not installed at time of order)

GLARE SHIELD ACCESSORIES

GSL-SQ-11-XXX	Square Glare Shield Long
GSA-SQ-11-XXX	Square Glare Shield Angled
GSS-SQ-11-XXX	Square Glare Shield Short

OPTIC ACCESSORIES

LVR-11	Hexcel Louver
OSL-11	Overall Spread Lens
LSL-11	Linear Spread Lens
SOL-11	Solite Soft Focus
DCF-11	Dichroic Filter
OPK-11	Optic Kit - Narrow, Medium, Wide

• Consult Accessory Spec Sheet for desired option code.
• XXX represents color option.

OUTDOOR MAGNETIC TRANSFORMERS (120V input/12VAC Output)

TRANSFORMERS (Go to [Accessories](#) for detailed specification)

EXAMPLE: TXM-300-OTR-SS

MODEL		WATTAGE (VA)				PRIMARY VOLTAGE (VAC)	
TXM	Stainless steel, wet location outdoor magnetic transformer Multitap 12-15VAC Output MLV Dimming	150	300			OTR-SS (120V Only)	
TXS	Stainless steel, wet location outdoor magnetic transformer Multitap 12VAC Output MLV Dimming	150	300	600		SS (120V Only)	
TXM	Compact, damp location magnetic transformer 12VAC Output MLV Dimming	20	40	60	100	120	
IGT	In ground outdoor magnetic transformer 12VAC Output MLV Dimming	50 (120V Only)		100	300	120	277
TXE	In-fixture or near mounted electronic transformer 12VAC Output ELV Dimming Enclosure by others	60				120	277

PRODUCT DRAWINGS

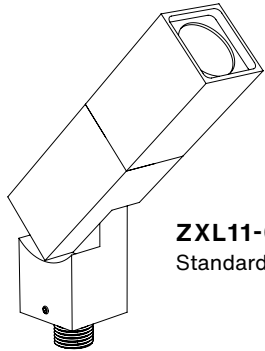

ZXL11-0S1SA
Standard

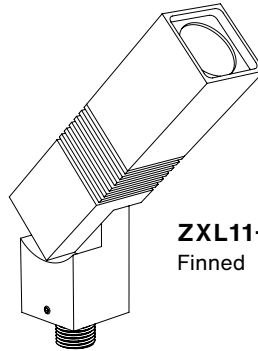

ZXL11-0S1FA
Finned

ZXL11-0S1S

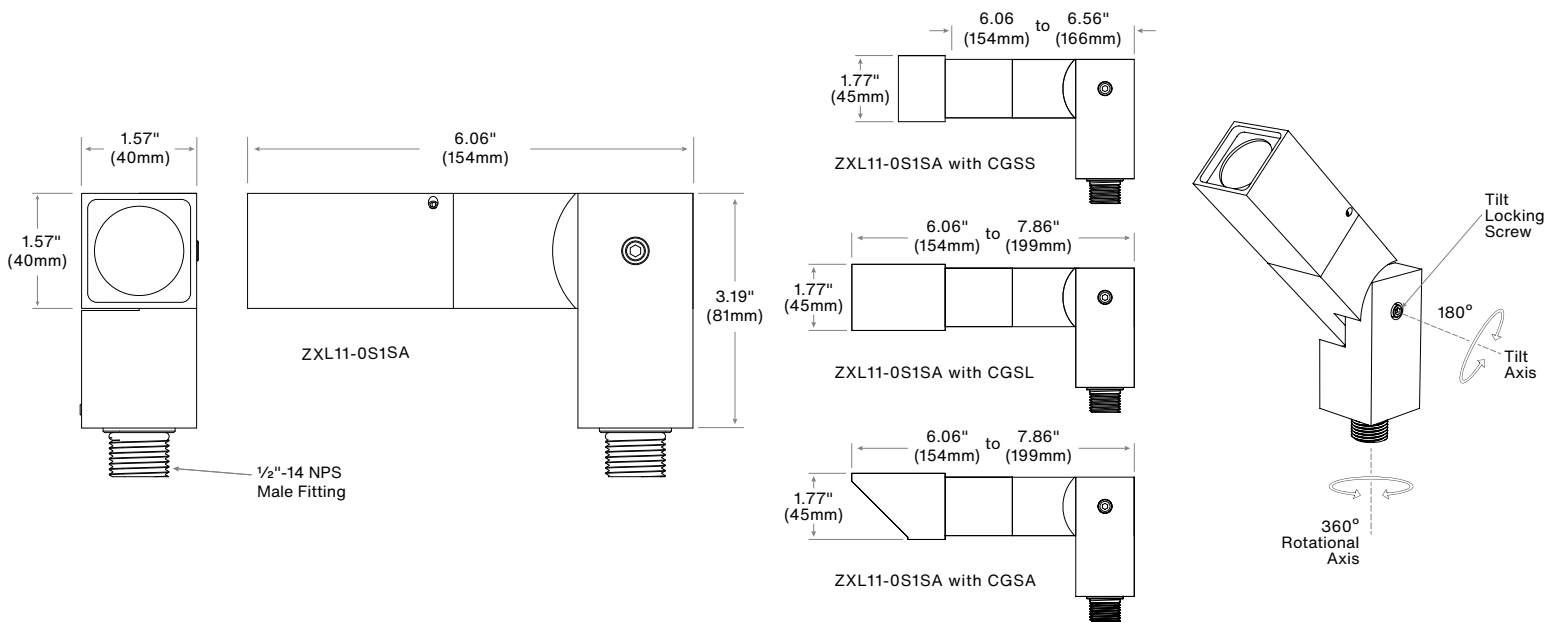

ZXL11-0S1F

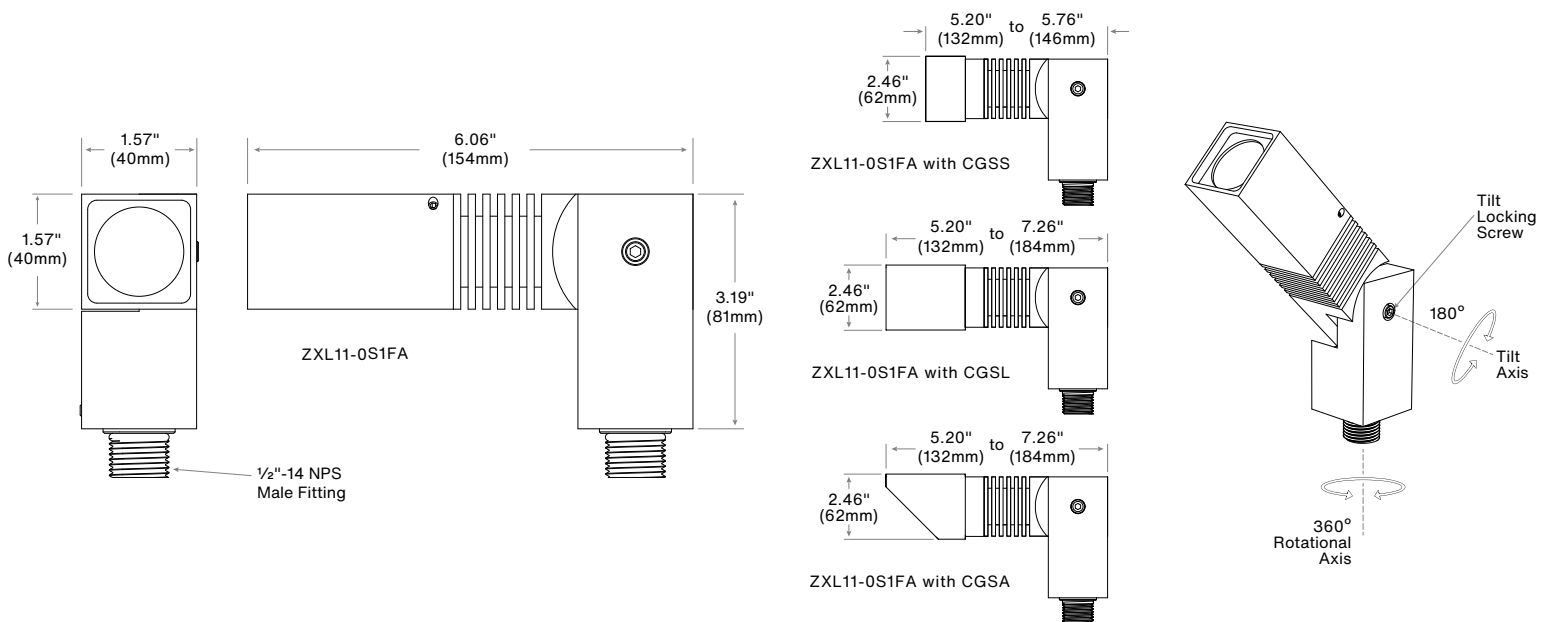

OPTIONS & ACCESSORIES

OPTIONAL GLARE SHIELD

For use with Square Hood,
fastened with Set Screw

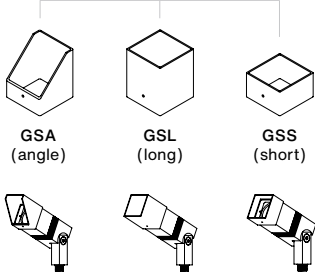

GSA
(angle)

GSL
(long)

GSS
(short)

MOUNTING ACCESSORIES

Canopy Mount:

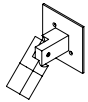

Fixture On CM3



CM2



CM1

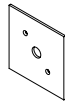

CM3



CM5



CM5-2

Surface Mount Box:

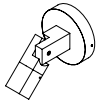

Fixture On CB5.1



CMLJ



CB3.5



CB4.0



CB4.0-SQ



CB5.1



CB5.1-2



CB5.5



CB5.5-2



CB5.5-K/O

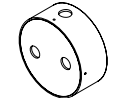

CB5.5-K/O-2

Ground Mount:

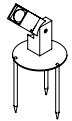

Fixture On MH02



MHCS



MH02-06



MH02-T-06



MH05



MH02-12



MH02-T-12



MHV6-12

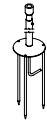

MHV12-24



MH01



JB-1

Tree Mount:

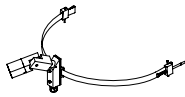

Fixture On TM125-TS



TM125

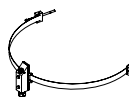

TM125-TS

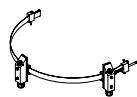

TM125-TS-2

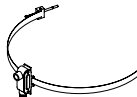

TM120-TS



TM125-HB



TM120-C-SM-HB



TMR2

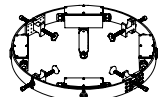

TS-SO

Extension:

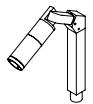

Fixture With EX,EL



EX



EL



ET

Sign Light Arm: Please reference the Sign & Pole Mounting section in [Accessories](#) on our website.

Notes:

PHOTOMETRY & ENERGY DATA

ZXL11 Square (Narrow)

Input Power	8.1W
Color Temperature (CCT)	3000K
Color Rendering Index (Ra)	80
Beam Angle	28.7°
Max. Candlepower	1964cd
Delivered Lumens	636lm
Efficacy	78lm/W

Polar Graph - Intensity

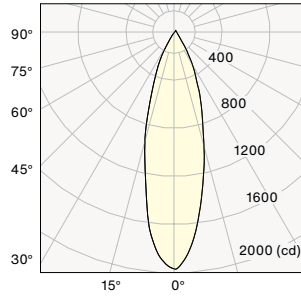

Cone of Light - Illuminance

Center Beam (fc)	Beam Diameter	Distance
491	1.0'	2.0'
123	2.0'	4.0'
55	3.0'	6.0'
31	4.0'	8.0'
20	5.0'	10.0'

1/2 Beam Angle: 28.7°

ZXL11 Square (Medium)

Input Power	8.1W
Color Temperature (CCT)	3000K
Color Rendering Index (Ra)	80
Beam Angle	39.2°
Max. Candlepower	1383cd
Delivered Lumens	632lm
Efficacy	78lm/W

Polar Graph - Intensity

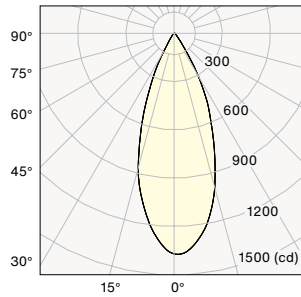

Cone of Light - Illuminance

Center Beam (fc)	Beam Diameter	Distance
346	1.4'	2.0'
86	2.9'	4.0'
38	4.3'	6.0'
22	5.7'	8.0'
14	7.1'	10.0'

1/2 Beam Angle: 39.2°

ZXL11 Square (Wide)

Input Power	8.1W
Color Temperature (CCT)	3000K
Color Rendering Index (Ra)	80
Beam Angle	56.9°
Max. Candlepower	811cd
Delivered Lumens	675lm
Efficacy	83lm/W

Polar Graph - Intensity

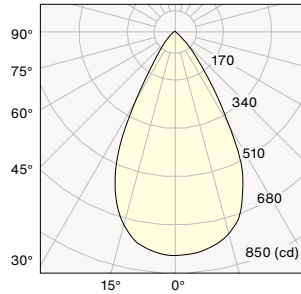

Cone of Light - Illuminance

Center Beam (fc)	Beam Diameter	Distance
203	2.2'	2.0'
135	4.3'	4.0'
23	6.5'	6.0'
13	8.7'	8.0'
8	10.8'	10.0'

1/2 Beam Angle: 56.9°

WATTAGE MULTIPLIER

Wattage	Multiplier
5 Watt	0.67
7 Watt	1.00

CCT MULTIPLIER

Color Temp.	Multiplier
2700k	0.96
3000k	1.00
4000k	1.03