

ZXL11

(includes former ZXL11 & ZXL11-NF models)

ACCENT & LANDSCAPE | ZX11 Series | 1.65" dia.
5 - 7W (450 - 675lm) | 12V | HK LED, RGB, Amber



IP67

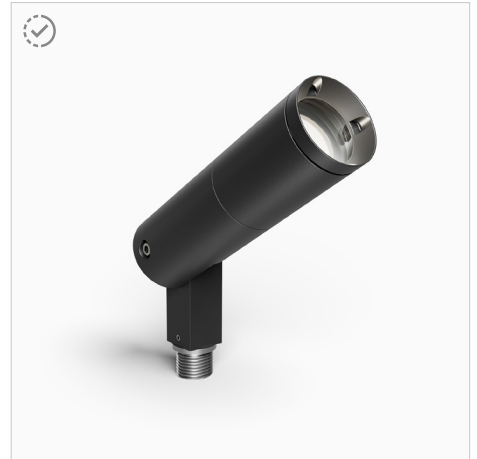

Standard Low Voltage Round Accent: ZXL11-0R1SA-ABL



Finned Low Voltage Round Accent: ZXL11-0R1FA-AAC

FEATURES

- Compact and powerful round, directional 12V LED modern accent light for architectural outdoor and landscape lighting environments. Most appropriate for medium to tall trees, architectural columns, and residential façades from 30 to 80 feet.
- 5W, 7W integrated HK LED delivering 450 to 675 lumens. 2200 - 4000K CCT, including specialty Amber and RGB options.
- Wet Location Listed, IP67 Standard.
- Machined from solid aircraft grade (6061-T6), corrosion-resistant aluminum, then anodized and powder coated to create a highly durable, marine grade finish. Also available in solid brass or stainless steel.
- 240° vertical and 360° horizontal adjustment via locking swivel stem design.
- Modular components, field changeable LED optical beams, and lenses.
- Available with adjustable Angled, Long, and Short Glare Shields and ground, surface, and canopy mounting options.
- Every fixture tested end of line for water tightness and light quality.
- Readymade eligible configurations ship in 2 to 4 weeks, complete with selected accessories installed.

SPECIFICATIONS

<p>Materials Solid billet 6061-T6 corrosion resistant aluminum with 316 stainless steel hardware. Available in 304/316 stainless steel or 360 brass upon request.</p> <p>Finish Aluminum materials are first anodized and then powder coated for a robust, marine grade finish. Stainless steel and brass models are provided with brushed surface.</p> <p>Hood and Glare Shield Weeping and Non-weeping Hood Styles. Set screw or threaded Angled, Short, or Long Glare Shields. <i>(See page 4 for details)</i></p>	<p>Voltage 12V AC/DC. Requires remote step down transformer.</p> <p>Wattage 5 or 7W HK LED delivers 450 to 675 lumens.</p> <p>Light Engine Innovative HK LED Light module operates like a lamp and can be easily changed in the field. CRI 90 Standard. Available in CRI 80 or CRI 95 upon request. Standard CCT options are 2700K, 3000K, 3500K, 4000K. Specialty 2200K, 2400K, 2500K, Amber, and RGB options available. Consult factory for specialty LED specification details.</p> <p>Dimming MLV or ELV Phase Control dimming.</p>	<p>Optics Narrow (29°), Medium (40°), Wide (57°) beam spread options available. Accepts up to 3 optical accessories (hexcel louver, optical lenses, dichroic color filters, etc.) Secured place with metal snap ring.</p> <p>Mounting Mounts using 1/2"-14 NPS male fitting compatible with all HK Lighting Group mounting devices. <i>(See page 4 for details)</i></p> <p>Listings ETL Listed for Wet Location, IP67 Standard. RoHS Compliant.</p>
--	---	--

ORDERING GUIDE

EXAMPLE: ZXL11-0R1SA-ABL-012V05W-27N-GSA-LVR-MHCS-06

MODEL	OPTIONS			MATERIAL / FINISH			POWER			LIGHT		
ZXL11	OR1						012V					
ZX11 Series 1.65" Accent Light Integrated HK LED	TYPE	STYLE	HOOD	ABL Aluminum Black	ABR Aluminum Bronze	AWH Aluminum White	VOLTAGE	WATTAGE	CCT	OPTICS		
	OR1 Low Voltage, Round Accent	S Standard F Finned	A A: Weeping B B: No Weep Holes C C: Threaded, Weeping	AAC Aluminum Anodized Clear ¹	NBR Natural Brass ¹	NCU Natural Copper ¹	012V 12V AC	05W 5 Watts (450lm) 07W 7 Watts (675lm) SPW Specialty ²	22 2200K 24 2400K 25 2500K 27 2700K 30 3000K 35 3500K 40 4000K AM Amber ² RG RGB ²	N Narrow (29°) M Medium (40°) W Wide (57°) CC Custom Optic		

Ready-made eligible configurations ship in 2 to 4 weeks

¹ For premium materials, please consult the factory for current lead times and pricing. A minimum order quantity of 10 units is required.

² For Specialty AM (Amber LED) and RG (RGB LED), select SPW (Specialty) for Wattage. Consult factory for LED technical details before Specification or Order.

OPTIONAL INSTALLED ACCESSORIES

GLARE SHIELD

GSA	A/B Glare Shield Angled
GSL	A/B Glare Shield Long
GSS	A/B Glare Shield Short
CGSA	C Glare Shield Angled
CGSL	C Glare Shield Long
CGSS	C Glare Shield Short

OPTIC

LVR	Hexcel Louver
OSL	Overall Spread Lens
LSL	Linear Spread Lens
SOL	Solite Soft Focus
DCF	Dichroic Filter

MOUNTING (Most common listed, see Page 4 for additional options)

GROUND MOUNT	
MHCS-06	6" PVC Single Prong Spike (12V)
MHCS-12	12" PVC Single Prong Spike (12V)
MH02-06-BRZ	6" Stainless Steel 3-Prong Spike (12V) Bronze
MH02-12-BRZ	12" Stainless Steel 3-Prong Spike (12V) Bronze
JB-1	Brass In-ground Junction Box
CANOPY MOUNT	
CM1-XXX	3.75" Square Canopy Plate
CM3-XXX	4.75" Square Canopy Plate
CM5-XXX	5" Round Canopy Plate
CM5-2-XXX	5" Round Canopy Plate - Double
SURFACE MOUNT	
CMLJ-XXX	2.7" Round Surface Box
CB4.0-XXX	4" Round Surface Box
CB5.5-XXX	5.5" Round Surface Box
TREE MOUNT	
TM125-ABR	Aluminum Tree Mount Box (12V)
TM125-TS-ABR	Stainless Steel Strap for TM125
EXTENSIONS	
EX-12-XXX	12" Extension
EX-24-XXX	24" Extension
EL-XXX	Elbow Extension

ADDITIONAL ACCESSORIES (Not installed at time of order)

GLARE SHIELD ACCESSORIES

GSL-11-XXX	A/B Glare Shield Long
GSA-11-XXX	A/B Glare Shield Angled
GSS-11-XXX	A/B Glare Shield Short
CGSL-11-XXX	C Glare Shield Long
CGSA-11-XXX	C Glare Shield Angled
CGSS-11-XXX	C Glare Shield Short

OPTIC ACCESSORIES

LVR-11	Hexcel Louver
OSL-11	Overall Spread Lens
LSL-11	Linear Spread Lens
SOL-11	Solite Soft Focus
DCF-11	Dichroic Filter
OPK-11	Optic Kit - Narrow, Medium, Wide

- Consult Accessory Spec Sheet for desired option code.
- XXX represents color option.
- Ready-made options available in ABL and ABR only unless noted by the part code above.

OUTDOOR MAGNETIC TRANSFORMERS (120V input/12VAC Output)

TRANSFORMERS (Go to [Accessories](#) for detailed specification)

EXAMPLE: TXS-150-SS

MODEL		WATTAGE (VA)				PRIMARY VOLTAGE (VAC)	
TXM	Stainless steel, wet location outdoor magnetic transformer Multitap 12-15VAC Output MLV Dimming	150	300			OTR-SS (120V Only)	
TXS	Stainless steel, wet location outdoor magnetic transformer Multitap 12VAC Output MLV Dimming	150	300	600		SS (120V Only)	
TXM	Compact, damp location magnetic transformer 12VAC Output MLV Dimming	20	40	60	100	120	
IGT	In ground outdoor magnetic transformer 12VAC Output MLV Dimming	50 (120V Only)		100	300	600	277
TXE	In-fixture or near mounted electronic transformer 12VAC Output ELV Dimming Enclosure by others	60				120	277

PRODUCT DRAWINGS

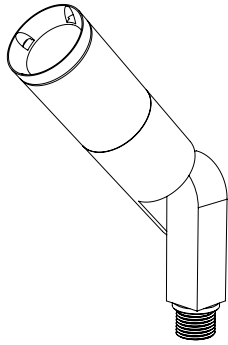

ZXL11-OR1S
Standard

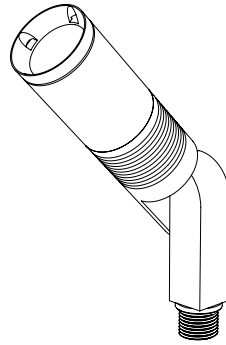

ZXL11-OR1F
Finned

ZXL11-OR1S

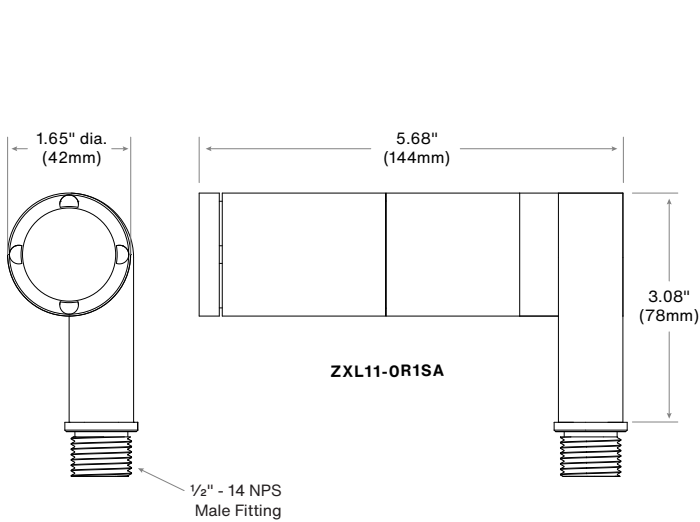

ZXL11-OR1SA

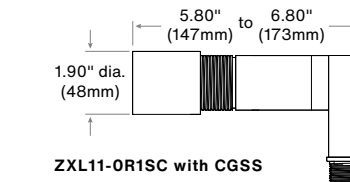

ZXL11-OR1SC with CGSS

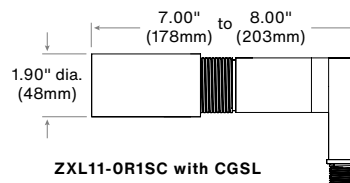

ZXL11-OR1SC with CGSL

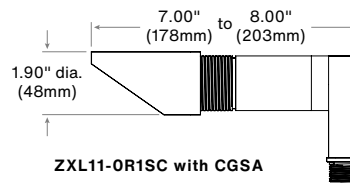

ZXL11-OR1SC with CGSA

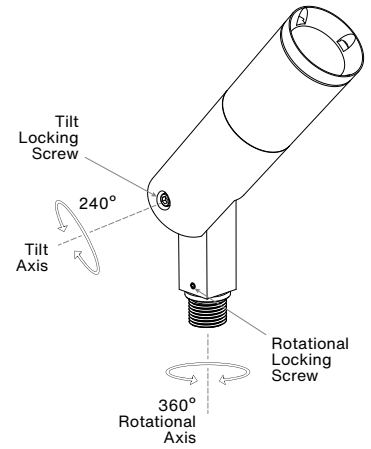

ZXL11-OR1F

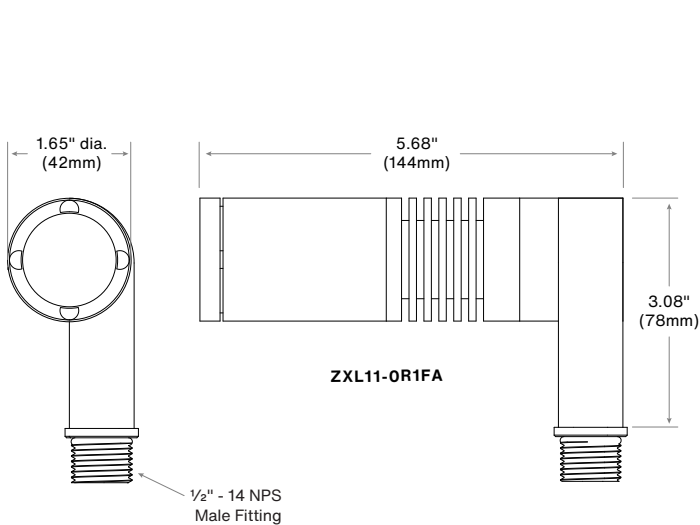

ZXL11-OR1FA

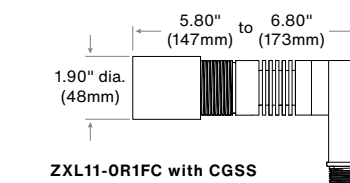

ZXL11-OR1FC with CGSS

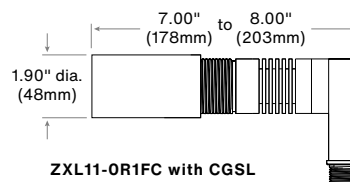

ZXL11-OR1FC with CGSL

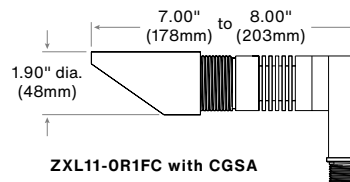

ZXL11-OR1FC with CGSA

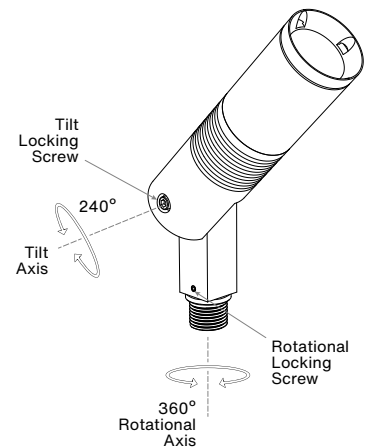

OPTIONS & ACCESSORIES

HOOD OPTIONS

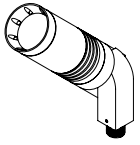

A HOOD

Versatile hood with 8 weep holes for water drainage. Regressed lens for glare control. Suggested for general use or when fixture is aimed in an up position.

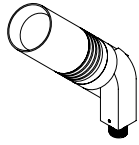

B HOOD

Similar to A hood but without weep holes. Regressed lens for glare control. Suggested for downlighting and interior applications.

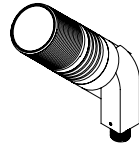

C HOOD

Designed for permanent use with a glare shield and innovative drainage design for water and debris. The machined threads enable ongoing glare shield adjustment, without impact to the paint surface.

OPTIONAL GLARE SHIELD

For use with A & B Hood, fastened with Set Screw

For use with C Hood fastened with Locking Ring



GSA
(angle)



GSL
(long)



GSS
(short)



CGSA
(angle)



CGSL
(long)



CGSS
(short)



MOUNTING ACCESSORIES

Canopy Mount:



Fixture On CM5



CM1



CM3



CM5



CM5-2



CM2

Surface Mount Box:



Fixture On CB5.1



CMLJ



CB4.0



CB5.5



CB3.5



CB4.0-SQ



CB5.1



CB5.1-2



CB5.5-2



CB5.5-2K



CB5.5-2-2K

Ground Mount:

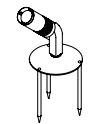

Fixture On MH02

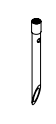

MHCS



MH02-06



MH02-12



JB-1



MH02-T-06



MH05



MH02-T-12



MHVL-06-12



MHVL-12-24



MH01

Tree Mount:

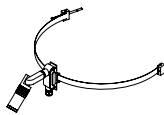

Fixture On TM120-TS

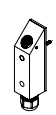

TM125

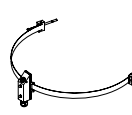

TM125-TS

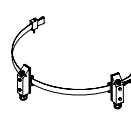

TM125-TS-2

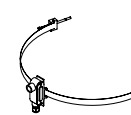

TM120-TS

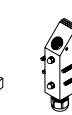

TM125-HB



TM120-C-SM-HB



TMR2

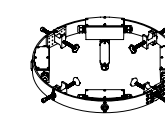

TS-SO

Extension:

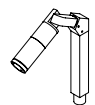

Fixture With EX,EL

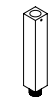

EX



EL

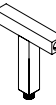

ET

Sign Light Arm: Please reference the Sign & Pole Mounting section in [Accessories](#) on our website.

Ready-made eligible configurations ship in 2 to 4 weeks.

Notes:

PHOTOMETRY & ENERGY DATA
ZXL11 (Narrow)

Input Power	8.1W
Color Temperature (CCT)	3000K
Color Rendering Index (Ra)	80
Beam Angle	28.7°
Max. Candlepower	1964cd
Delivered Lumens	636lm
Efficacy	78lm/W

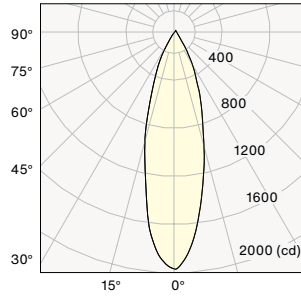
Polar Graph - Intensity

Cone of Light - Illuminance

Center Beam (fc)	Beam Diameter	Distance
491	1.0'	2.0'
123	2.0'	4.0'
55	3.0'	6.0'
31	4.0'	8.0'
20	5.0'	10.0'

1/2 Beam Angle: 28.7°

ZXL11 (Medium)

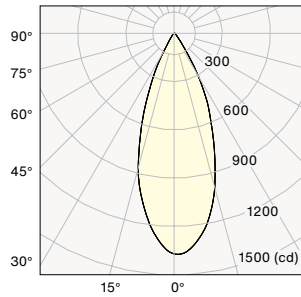
Input Power	8.1W
Color Temperature (CCT)	3000K
Color Rendering Index (Ra)	80
Beam Angle	39.2°
Max. Candlepower	1383cd
Delivered Lumens	632lm
Efficacy	78lm/W

Polar Graph - Intensity

Cone of Light - Illuminance

Center Beam (fc)	Beam Diameter	Distance
346	1.4'	2.0'
86	2.9'	4.0'
38	4.3'	6.0'
22	5.7'	8.0'
14	7.1'	10.0'

1/2 Beam Angle: 39.2°

ZXL11 (Wide)

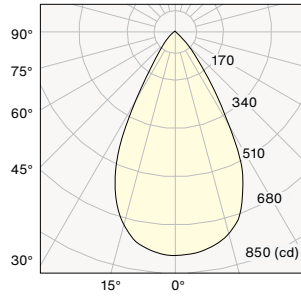
Input Power	8.1W
Color Temperature (CCT)	3000K
Color Rendering Index (Ra)	80
Beam Angle	56.9°
Max. Candlepower	811cd
Delivered Lumens	675lm
Efficacy	83lm/W

Polar Graph - Intensity

Cone of Light - Illuminance

Center Beam (fc)	Beam Diameter	Distance
203	2.2'	2.0'
135	4.3'	4.0'
23	6.5'	6.0'
13	8.7'	8.0'
8	10.8'	10.0'

1/2 Beam Angle: 56.9°

WATTAGE MULTIPLIER

Wattage	Multiplier
5 Watt	0.67
7 Watt	1.00

CCT MULTIPLIER

Color Temp.	Multiplier
2700k	0.96
3000k	1.00
4000k	1.03