

ZXL16 SQUARE

IP67

(includes former ZXL16-SQ and ZXL16-SQ-NF models)

ACCENT & LANDSCAPE | ZX16 Series | 2.25"

5 - 10W (500 - 900LM) | 12V | HK LED, RGB, Amber

FEATURES

- Our most versatile square, directional 12V LED modern accent light for residential and commercial environments.
- 5W, 7W, 10W integrated HK LED delivering 500 to 900 lumens. 2200-4000K CCT, including specialty Amber and RGB options.
- Wet Location Listed, IP67 Standard.
- Machined from solid aircraft grade (6061-T6), corrosion-resistant aluminum, then anodized and powder coated to create a highly durable, marine grade finish. Also available in solid brass or stainless steel.
- 90° vertical and 360° horizontal adjustment via locking swivel stem design.
- Modular components, field changeable LED optical beams, and lenses.
- Available with adjustable Angled, Long, and Short Glare Shields and ground, surface, and canopy mounting options.
- Every fixture tested end of line for water tightness and light quality.
- Ships complete with selected accessories installed.



Finned Low Voltage Square Accent: ZXL16-0S1FA-AAC

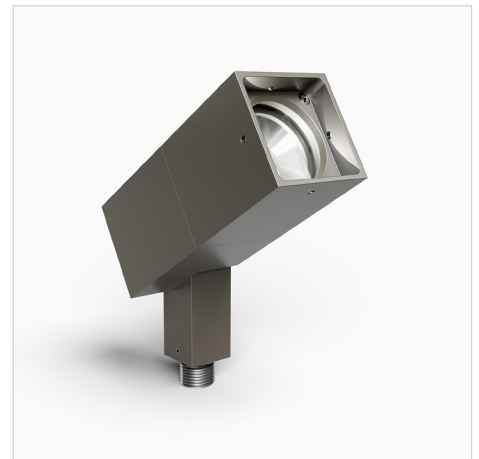

Standard Low Voltage Square Accent: ZXL16-0S1SA-ABR

SPECIFICATIONS

Materials

Machined from billet 6061-T6 corrosion resistant aluminum with 304 stainless steel hardware. Available in 304/316 stainless steel or 360 brass upon request.

Finish

Aluminum materials are first anodized and then powder coated for a robust, marine grade finish. Stainless steel and brass models are provided with brushed surface.

Hood and Glare Shield

Weeping Hood Style with Angled, Short, or Long Glare Shields. *(See page 4 for details).*

Voltage

12V AC/DC. Requires remote step down transformer.

Wattage

5, 7, or 10W HK LED delivering 500 to 900 lumens.

Light Engine

Innovative HK LED Light module operates like a lamp and can be easily changed in the field. CRI 90 Standard. Available in CRI 80 or CRI 95 upon request. Standard CCT options are 2700K, 3000K, 3500K, 4000K. Specialty 2200K, 2400K, 2500K, Amber, and RGB options available. Consult factory for specialty LED specification details.

Dimming

MLV or ELV Phase Control dimming.

Optics

Narrow (20°), Medium (33°), Wide (44°) beam spread options available. Accepts up to 3 optical accessories (hexcel louver, optical lenses, dichroic color filters, etc.) Secured place with metal snap ring.

Mounting

Mounts using 1/2"-14 NPS male fitting compatible with all HK Lighting Group mounting devices. *(See page 4 for details).*

Listings

ETL Listed for Wet Location, IP67 Standard. RoHS Compliant.

ORDERING GUIDE

EXAMPLE: ZXL16-0S1SA-ABL-012V05W-22N-GSA-LVR-MHCS-06

| MODEL | OPTIONS | | | | MATERIAL / FINISH | | POWER | | LIGHT | | | | |
|---------------------------------------------------------|------------------------------------------|--------------------------------------|-------------|------------|----------------------------------------------------|--|--------------------|-----------------------------------|------------------------------|------------|------------------|---------------|--|
| ZXL16 | OS1 | | | A | | | 012V | | | | | | |
| ZXL16 Series 2.25" Accent Light Integrated HK LED | TYPE | STYLE | HOOD | | ABL Aluminum Black | | VOLTAGE | WATTAGE | | CCT | | OPTICS | |
| | OS1 Low Voltage, Square Accent | S Standard F Finned | A | A: Weeping | ABR Aluminum Bronze | | 012V 12V AC | 05W 5 Watts (500lm) | 22 2200K | N | Narrow (20°) | | |
| | | | | | AWH Aluminum White | | | 07W 7 Watts (700lm) | 24 2400K | M | Medium (33°) | | |
| | | | | | AAC Aluminum Anodized Clear ¹ | | | 10W 10 Watts (900lm) | 25 2500K | W | Wide (44°) | | |
| | | | | | NBR Natural Brass ¹ | | | SPW Specialty ² | 27 2700K | E | Extra Wide (57°) | | |
| | | | | | NCU Natural Copper ¹ | | | | 30 3000K | CC | Custom Optic | | |
| | | | | | NSS Natural Stainless Steel ¹ | | | | 35 3500K | | | | |
| | | | | | CCC Custom Finish ¹ | | | | 40 4000K | | | | |
| | | | | | | | | | AM Amber ² | | | | |
| | | | | | | | | | RG RGB ² | | | | |

¹ Consult factory for specialty finish quoting and lead times

² For Specialty AM (Amber LED) and RG (RGB LED), select SPW (Specialty) for Wattage. Consult factory for LED technical details before Specification or Order.

OPTIONAL INSTALLED ACCESSORIES

GLARE SHIELD

| | |
|------------|-------------------------|
| GSA | A/B Glare Shield Angled |
| GSL | A/B Glare Shield Long |
| GSS | A/B Glare Shield Short |

OPTIC

| | |
|------------|---------------------|
| LVR | Hexcel Louver |
| OSL | Overall Spread Lens |
| LSL | Linear Spread Lens |
| SOL | Solite Soft Focus |
| DCF | Dichroic Filter |

MOUNTING (Most common listed, see Page 4 for additional options)

| | |
|----------------------|------------------------------------------------|
| GROUND MOUNT | |
| MHCS-06 | 6" PVC Single Prong Spike (12V) |
| MHCS-12 | 12" PVC Single Prong Spike (12V) |
| MH02-06-BRZ | 6" Stainless Steel 3-Prong Spike (12V) Bronze |
| MH02-12-BRZ | 12" Stainless Steel 3-Prong Spike (12V) Bronze |
| JB-1 | Brass In-ground Junction Box |
| CANOPY MOUNT | |
| CM1-XXX | 3.75" Square Canopy Plate |
| CM3-XXX | 4.75" Square Canopy Plate |
| CM5-XXX | 5" Round Canopy Plate |
| CM5-2-XXX | 5" Round Canopy Plate - Double |
| SURFACE MOUNT | |
| CMLJ-XXX | 2.7" Round Surface Box |
| CB4.0-XXX | 4" Round Surface Box |
| CB5.5-XXX | 5.5" Round Surface Box |
| TREE MOUNT | |
| TM125-ABR | Aluminum Tree Mount Box (12V) |
| TM125-TS-ABR | Stainless Steel Strap for TM125 |
| EXTENSIONS | |
| EX-12-XXX | 12" Extension |
| EX-24-XXX | 24" Extension |
| EL-XXX | Elbow Extension |

ADDITIONAL ACCESSORIES (Not installed at time of order)

GLARE SHIELD ACCESSORIES

| | |
|----------------------|-------------------------|
| GSL-SQ-16-XXX | A/B Glare Shield Long |
| GSA-SQ-16-XXX | A/B Glare Shield Angled |
| GSS-16-SQ-XXX | A/B Glare Shield Short |

OPTIC ACCESSORIES

| | |
|---------------|----------------------------------|
| LVR-16 | Hexcel Louver |
| OSL-16 | Overall Spread Lens |
| LSL-16 | Linear Spread Lens |
| SOL-16 | Solite Soft Focus |
| DCF-16 | Dichroic Filter |
| OPK-16 | Optic Kit - Narrow, Medium, Wide |

- Consult Accessory Spec Sheet for desired option code.
- XXX represents color option.

OUTDOOR MAGNETIC TRANSFORMERS (120V input/12VAC Output)

TRANSFORMERS (Go to [Accessories](#) for detailed specification)

EXAMPLE: TXM-20-120

| MODEL | | WATTAGE (VA) | PRIMARY VOLTAGE (VAC) |
|------------|----------------------------------------------------------------------------------------------------------------------------------|----------------------------------|-----------------------|
| TXM | Compact, damp location magnetic transformer 12VAC Output MLV Dimming | 20, 40, 60, 100, 150, 300 | 120, 277 |
| TXM | Stainless steel, wet location outdoor magnetic transformer with integrated light sensor Multitap 12VAC Output MLV Dimming | 300 | OTR-SS (120V Only) |
| TXS | Stainless steel, wet location outdoor magnetic transformer Multitap 12VAC Output MLV Dimming | 150, 300, 600 | -SS (120V Only) |
| IGT | In-grade outdoor magnetic transformer 12VAC Output MLV Dimming | 50 (120V Only), 100, 300, 600 | 120, 277 |
| TXE | In-fixture or near mounted electronic transformer 12VAC Output ELV Dimming Enclosure by others | 60 | 120, 230, 277 |

PRODUCT DRAWINGS

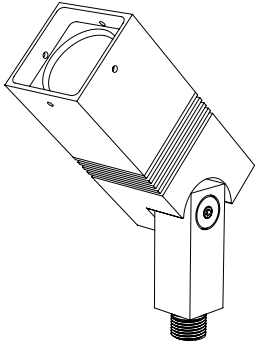

ZXL16-0S1FA
Finned

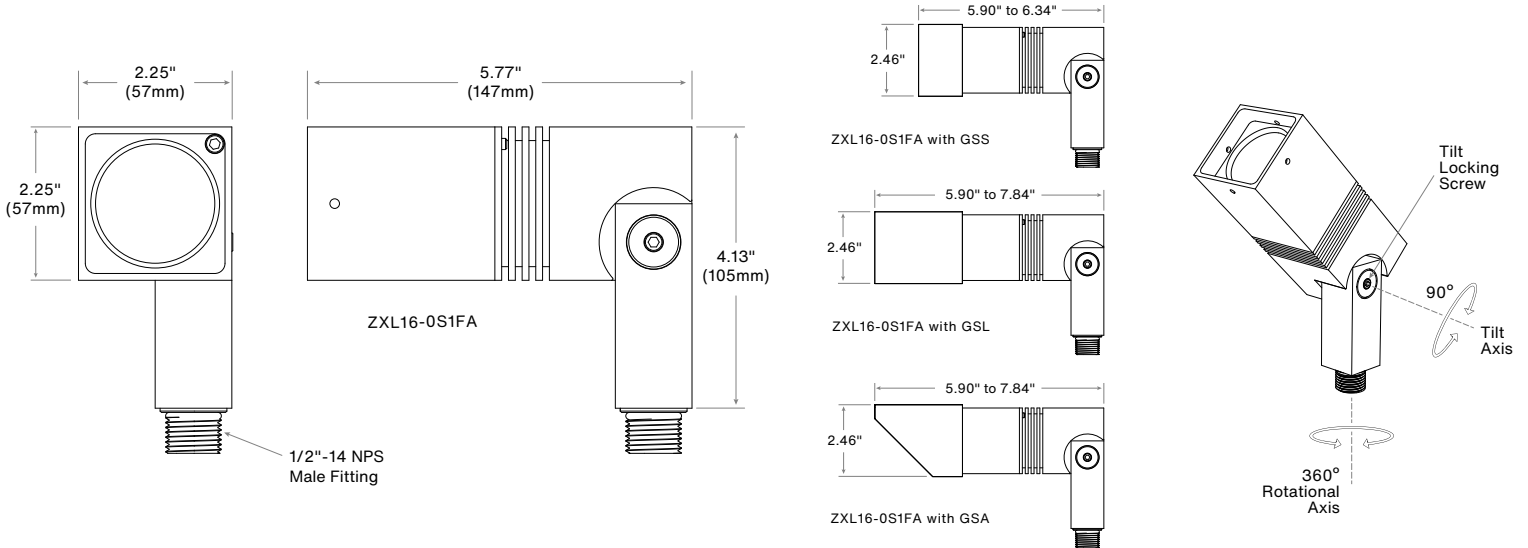

OPTIONS & ACCESSORIES
OPTIONAL GLARE SHIELD

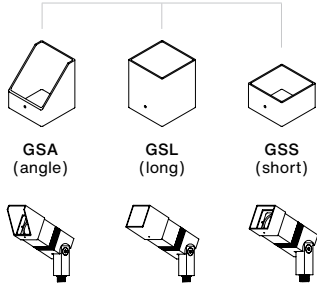
 For use with SQ Hood,
fastened with Set Screw

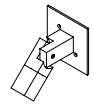
GSA
(angle) **GSL**
(long) **GSS**
(short)

MOUNTING ACCESSORIES
Canopy Plate:

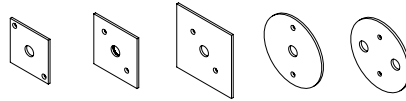
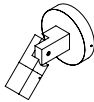
Fixture On CM3

CM2 **CM1** **CM3** **CM5** **CM5-2**
Surface Mount Box:

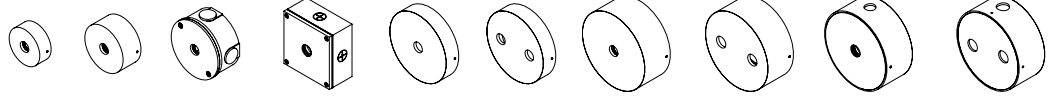
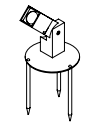
Fixture On CB5.1

CMLJ **CB3.5** **CB4.0** **CB4.0-SQ** **CB5.1** **CB5.1-2** **CB5.5** **CB5.5-2** **CB5.5-K/O** **CB5.5-K/O-2**
Ground Mount:

Fixture On MH02

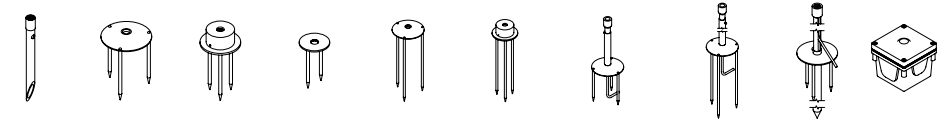
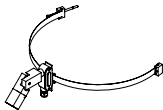
MHCS **MH02** **MH02-T** **MH05** **MH02-12** **MH02-T-12** **MHVL6-12** **MHVL12-24** **MH01** **JB-1**
Tree Mount:

Fixture On TM120-TS

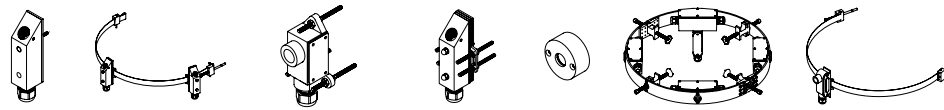
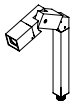
TM125 **TM125-TS-2** **TM120-C-SM-HB** **TM125-HB** **TMR2** **TS-SO** **TM120-TS**
Extension:

Fixture With EX,EL

EX **EL** **T-BAR**
Sign Light Arm: Please reference the Sign & Pole Mounting section in [Accessories](#) on our website.

Notes:

PHOTOMETRY & ENERGY DATA

ZXL16-SQ-10W-N (Narrow)

| | |
|----------------------------|--------|
| Input Power | 9.5W |
| Color Temperature (CCT) | 3000K |
| Color Rendering Index (Ra) | 83 |
| Beam Angle | 20.5° |
| Max. Candlepower | 3507cd |
| Delivered Lumens | 864lm |
| Efficacy | 91lm/W |

Polar Graph - Intensity

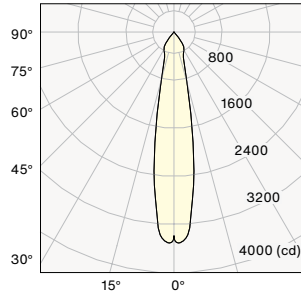

Cone of Light - Illuminance

| Center Beam (fc) | Beam Diameter | Distance |
|------------------|---------------|----------|
| 877 | 0.7' | 2.0' |
| 219 | 1.4' | 4.0' |
| 97 | 2.2' | 6.0' |
| 55 | 2.9' | 8.0' |
| 35 | 3.6' | 10.0' |

1/2 Beam Angle: 20.5°

ZXL16-SQ-10W-M (Medium)

| | |
|----------------------------|--------|
| Input Power | 9.5W |
| Color Temperature (CCT) | 3000K |
| Color Rendering Index (Ra) | 83 |
| Beam Angle | 32.5° |
| Max. Candlepower | 1842cd |
| Delivered Lumens | 863lm |
| Efficacy | 91lm/W |

Polar Graph - Intensity

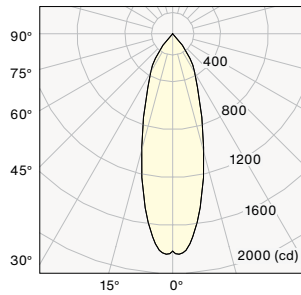

Cone of Light - Illuminance

| Center Beam (fc) | Beam Diameter | Distance |
|------------------|---------------|----------|
| 460 | 1.2' | 2.0' |
| 115 | 2.3' | 4.0' |
| 51 | 3.5' | 6.0' |
| 29 | 4.6' | 8.0' |
| 18 | 5.8' | 10.0' |

1/2 Beam Angle: 32.5°

ZXL16-SQ-10W-W (Wide)

| | |
|----------------------------|--------|
| Input Power | 9.5W |
| Color Temperature (CCT) | 3000K |
| Color Rendering Index (Ra) | 83 |
| Beam Angle | 44.1° |
| Max. Candlepower | 1332cd |
| Delivered Lumens | 850lm |
| Efficacy | 89lm/W |

Polar Graph - Intensity

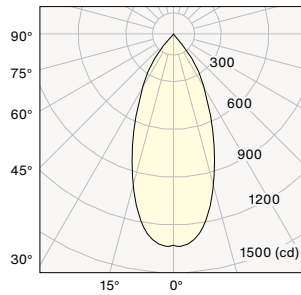

Cone of Light - Illuminance

| Center Beam (fc) | Beam Diameter | Distance |
|------------------|---------------|----------|
| 333 | 1.6' | 2.0' |
| 83 | 3.2' | 4.0' |
| 37 | 4.9' | 6.0' |
| 21 | 6.5' | 8.0' |
| 13 | 8.1' | 10.0' |

1/2 Beam Angle: 44.1°

ZXL16-SQ-10W-E (Extra Wide)

| | |
|----------------------------|--------|
| Input Power | 9.5W |
| Color Temperature (CCT) | 3000K |
| Color Rendering Index (Ra) | 83 |
| Beam Angle | 56.9° |
| Max. Candlepower | 1019cd |
| Delivered Lumens | 876lm |
| Efficacy | 92lm/W |

Polar Graph - Intensity

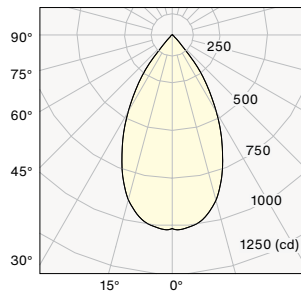

Cone of Light - Illuminance

| Center Beam (fc) | Beam Diameter | Distance |
|------------------|---------------|----------|
| 255 | 2.3' | 2.0' |
| 64 | 4.6' | 4.0' |
| 28 | 6.9' | 6.0' |
| 16 | 9.2' | 8.0' |
| 10 | 11.5' | 10.0' |

1/2 Beam Angle: 56.9°

WATTAGE MULTIPLIER

| Wattage | Multiplier |
|---------|------------|
| 5 Watt | 0.53 |
| 7 Watt | 0.77 |
| 10 Watt | 1.00 |

CCT MULTIPLIER

| Color Temp. | Multiplier |
|-------------|------------|
| 2700k | 0.97 |
| 3000k | 1.00 |
| 4000k | 1.05 |