

ZXL38-IG

(includes former ZXL38i-GM-ADJ model)

ACCENT & LANDSCAPE | ZX38 Series | 5.32"

54W (5000lm) | 120 - 227V | HK LED, RGBW, Amber

**IP67**

Line Voltage LED Surface Mount: ZXL38-IG1SG-ABL

FEATURES

- Versatile surface mount 120-277V LED accent light for commercial and large residential environments.
- 28W, 42W, 54W integrated HK LED delivering 2700 to 5000 lumens.
- Wet Location Listed, IP65 Standard.
- Machined from solid aircraft grade (6061-T6), corrosion-resistant aluminum, then anodized and powder coated to create a highly durable, marine grade finish. Also available in solid brass or stainless steel.
- Surface mount with fully adjustable aiming, 360° rotation and 15° tilting.
- Modular components, field changeable LED optical beams, and lenses.
- Every fixture tested end of line for water tightness and light quality.
- Ships complete with selected accessories installed.

SPECIFICATIONS

Materials

Machined from billet 6061-T6 corrosion resistant aluminum with 304 stainless steel hardware. Available in 304/316 stainless steel or 360 brass upon request.

Finish

Aluminum materials are first anodized and then powder coated for a robust, marine grade finish. Stainless steel and brass models are provided with brushed surface.

Voltage

120-277V AC

Wattage

28W, 42W, 54W HK LED delivering 2700 to 5000 lumens.

Light Engine

Innovative HK LED Light module operates like a lamp and can be easily changed in the field. CRI 90 Standard. Available in CRI 80 or CRI 95 upon request. Standard CCT options are 2700K, 3000K, 3500K, 4000K. Specialty 2200K, 2400K, 2500K, Amber, and RGBW options available. Consult factory for specialty LED specification details.

Dimming

Onboard, Integrated LED Driver, Phase Control @ 120V, 0-10V @ 120-277V, DALI or DMX control available, consult factory for details.

Optics

Narrow (16°), Medium (26°), Wide (60°) beam spread options available. Accepts up to 3 optical accessories (hexcel louver, optical lenses, dichroic color filters, etc.) Secured place with metal snap ring.

Mounting

Mounts with 3/8"-16 NPS Anchor Bolt.

Listings

ETL Listed for Wet Location, IP65 Standard. RoHS Compliant.

ORDERING GUIDE

EXAMPLE: ZXL38-IG1SG-ABL-120V28W-27N-LVR

MODEL	PHYSICAL OPTIONS			MATERIAL / FINISH		POWER		LIGHT	
ZXL38	IG1	S	G						
ZX38 Series 5.5" Accent Light Integrated HK LED	TYPE	STYLE	HOOD	ABL Aluminum Black		VOLTAGE	WATTAGE	CCT	OPTICS
	IG1 Line Voltage, Ground Mounted Adjustable Accent Integrated Driver	S Standard	G G Style: Ground Mount	ABR Aluminum Bronze		120V 120V (Phase Control)	28W 28 Watt (2700lm)	22 2200K	N Narrow (16°)
				AWH Aluminum White		UNIV 120V-277V (0-10V)	42W 42 Watt (4100lm)	24 2400K	M Medium (26°)
				AAC Aluminum Anodized Clear ¹				25 2500K	W Wide (60°)
				NBR Natural Brass ¹			SPW Speciality ²	27 2700K	CC Custom Optic
				NCU Natural Copper ¹				30 3000K	
				NSS Natural Stainless Steel ¹				35 3500K	
				CCC Custom Finish ¹				40 4000K	
								AM Amber ²	
								RG RGBW ²	

¹ Consult factory for specialty finish quoting and lead times

² For Specialty AM (Amber LED) and RG (RGBW LED), select SPW (Specialty) for Wattage. Consult factory for LED technical details before Specification or Order.

OPTIONAL INSTALLED ACCESSORIES

OPTIC

OPTIC	
LVR	Hexcel Louver
OSL	Overall Spread Lens
LSL	Linear Spread Lens
SOL	Solite Soft Focus
DCF	Dichotic Filter

ADDITIONAL ACCESSORIES (Not installed at time of order)

OPTIC ACCESSORIES

OPTIC ACCESSORIES	
LVR-38	Hexcel Louver
OSL-38	Overall Spread Lens
LSL-38	Linear Spread Lens
SOL-38	Solite Soft Focus
DCF-38	Dichotic Filter
OPK-38	Optic Kit - Narrow, Medium, Wide

PRODUCT DRAWINGS

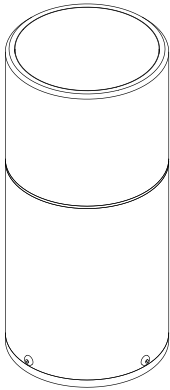

ZXL38-IG1SG

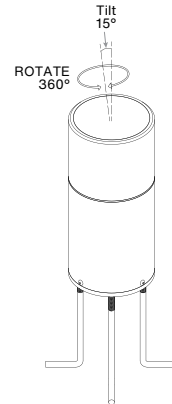
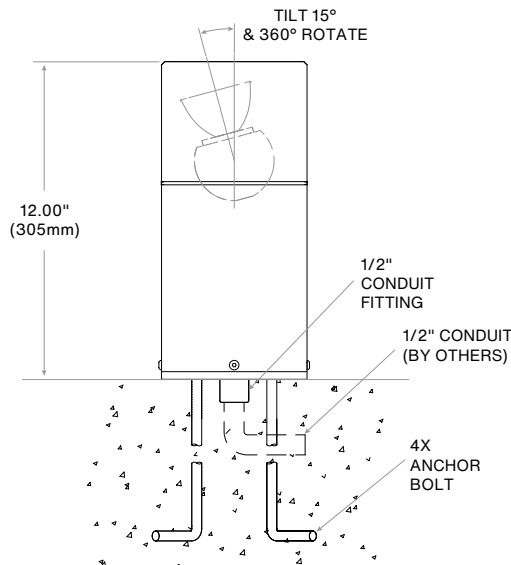
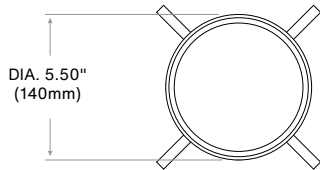

Notes:

Blank area for notes.

PHOTOMETRY & ENERGY DATA

ZXL38-IG-N28W-N (Narrow)

Input Power	28.2W
Color Temperature (CCT)	3000K
Color Rendering Index (Ra)	83
Beam Angle	16.1°
Max. Candlepower	17751cd
Delivered Lumens	2652lm
Efficacy	94lm/W

Polar Graph - Intensity

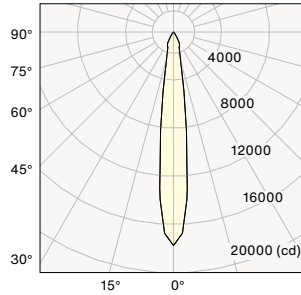

Cone of Light - Illuminance

Center Beam (fc)	Beam Diameter	Distance
4438	0.6'	2.0'
1109	1.1'	4.0'
493	1.7'	6.0'
277	2.3'	8.0'
178	2.8'	10.0'

1/2 Beam Angle: 16.1°

ZXL38-IG-N28W-M (Medium)

Input Power	28.0W
Color Temperature (CCT)	3000K
Color Rendering Index (Ra)	83
Beam Angle	25.5°
Max. Candlepower	9513cd
Delivered Lumens	2702lm
Efficacy	97lm/W

Polar Graph - Intensity

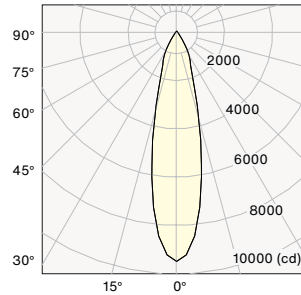

Cone of Light - Illuminance

Center Beam (fc)	Beam Diameter	Distance
2378	0.9'	2.0'
595	1.8'	4.0'
264	2.7'	6.0'
149	3.6'	8.0'
95	4.5'	10.0'

1/2 Beam Angle: 25.5°

ZXL38-IG-N28W-W (Wide)

Input Power	29.0W
Color Temperature (CCT)	3000K
Color Rendering Index (Ra)	83
Beam Angle	60.1°
Max. Candlepower	2926cd
Delivered Lumens	2667lm
Efficacy	92lm/W

Polar Graph - Intensity

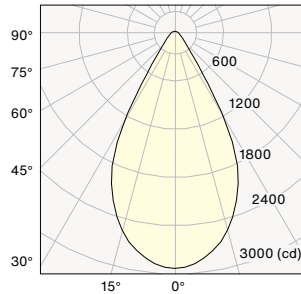

Cone of Light - Illuminance

Center Beam (fc)	Beam Diameter	Distance
731	2.3'	2.0'
183	4.6'	4.0'
81	6.9'	6.0'
46	9.3'	8.0'
29	11.6'	10.0'

1/2 Beam Angle: 60.1°

WATTAGE MULTIPLIER

Type	Wattage	Multiplier
N28	28 Watt	1.00
N42	42 Watt	1.5

CCT MULTIPLIER

Color Temp.	Multiplier
2700k	0.97
3000k	1.00
4000k	1.05
Turntable White	consult factory