

ZX16-CM-GU10/ZX16-CM-GU10-SOi

Ceiling Mount . ZX16 Series



Product Features

- Ceiling mount lighting for architectural and down light application.
- ETL outdoor wet location listed. IP65 standard.
- Machined from solid billet 6061-T6 corrosion resistant aluminum.
- US patented integral SORAA® heat sink.
- 120V input with GU10 MR16 LED. No transformer needed.

Integral SORAA® Heat Sink: US patented Thermobuster™ provides extra heat dissipation that reduces the lamp junction temperature by 77°F(25°C). Enables even the highest wattage SORAA® lamps to be used in an enclosed fixture without sacrificing its performance or life expectancy.

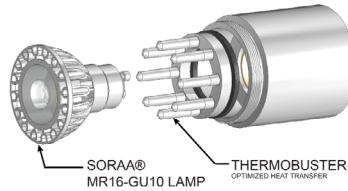

Specification

Materials: Machined from billet 6061-T6 corrosion resistant aluminum with 304 stainless steel hardware. Available in 304/316 stainless steel or 360 brass upon request.

Hood and Glare Shield: 2 available hood options to suit any application. 3 optional glare shields (short, long, angled) to complement each hood choice. See page 2 for details.

Light Source: MR16 GU10 Halogen lamp or MR16 GU10 SORAA® LED lamp. Please refer to [SORAA MR16 GU10](#) for lamp selection.

Voltage: 120 or 230V AC.

Wattage: Max. 9W for SORAA MR16 lamp with Thermobuster. Max. 35W for halogen MR16.

Lamp Base/Socket: Porcelain GU10 twist - lock lamp base.

Dimmability: Phase dimming. Please refer to website for SORAA® MR16 dimmer compatibility. [SORAA GU10 dimmer compatibility](#).

Finish: Polyester powder coat on all aluminum materials with RoHS compliant procedures. Anodized finish is available. Stainless steel and brass models are provided with brushed surface.

Optical Accessories: Accepts up to 3 accessory pieces (hexcel louver, optical lenses, dichroic color filters, etc.). Secured in place with metal snap ring.

Mounting Method: Utilizes 2x 8-32 UNC machine screws (provided) to attach to a standard octagon recessed back box (provided by others).

Ordering Guide

EXAMPLE: ZX16-CM-GU10-SOi - B - GSL - 01109 - BK - LVR - CM5
ZX16-CM-GU10 - B - GSL - 0 - BK - LVR - CM5

SERIES	MATERIAL	HOOD	OPTIONAL GLARE SHIELD	VOLTAGE	OPTIONAL LAMP	FINISH	OPTIONAL SELECT UP TO 3 OPTIC ACCESSORIES	OPTIONAL MOUNTING ACCESSORIES
ZX16-CM-GU10 HALOGEN	BLANK Aluminum(Standard) NBR Natural Brass NSS Natural Stainless Steel CU Natural Copper	B B-HOOD	GSL GSA GSS	120V 230V	0-NONE XXXXX SORAA® LAMP CODE (5 DIGIT SORAA CAT. NO®)	Standard BK Black Powder Coat BZ Bronze Powder Coat WT White Powder Coat Premium ABK Anodized Black ACL Anodized Clear CC Custom Powder Coat	LVR Hexcel Louver OSL Overall Spread Lens LSL Linear Spread Lens SOL Solite Soft Focus DF Dichroic Filter	See page 2 for quick reference, or "Accessories" link for detailed specification.
ZX16-CM-GU10-SOi SORAA®		C C-HOOD	CGSL CGSA CGSS					

*SORAA® Lamp Selection : [SORAA MR16 GU10](#)

Product Drawings

NOTE: Specification and dimensions subject to change without notice.

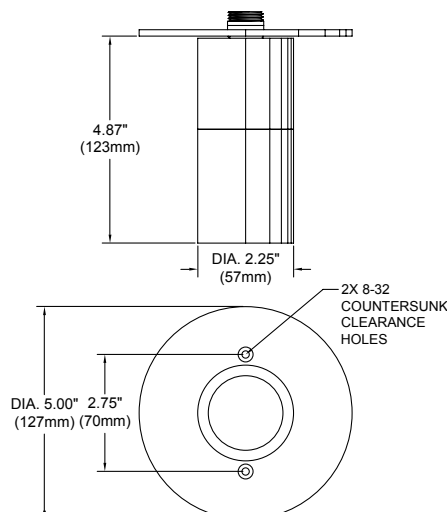

Photometry & Energy Data

All SORAA® MR16 GU10 base lamps can be used in this fixture.
Please refer to SORAA® website: [SORAA MR16 GU10](http://www.soraa.com)

Product Options & Accessories

Hood Options

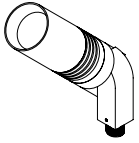

B-HOOD
Regressed lens for glare control. Used in an interior or down light application.

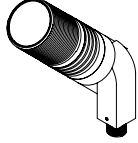

C-HOOD
Flush hood with machined threading on the outside for attachment of C-style glare shield, cleverly designed with hidden drainage channels.

Optional Glare Shield

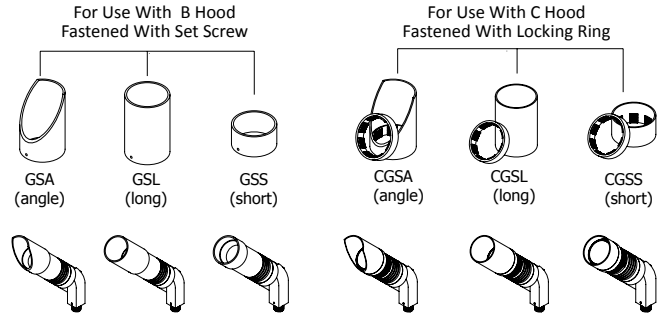

Mounting Accessories

Canopy Plate:

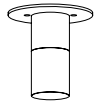

Fixture On CM5

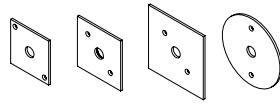

CM2 CM1 CM3 CM5

Surface Mount Box:

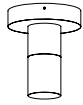

Fixture On CB5.1

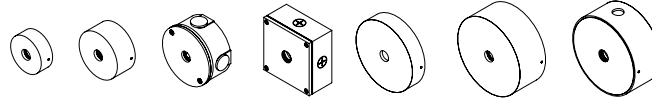

CMLJ CB3.5 CB4.0 CB4.0-SQ CB5.1 CB5.5 CB5.5-K/O

Notes