

# ZX16i-WM2/ZX16i-WM2-SOi

Wall Mount . ZX16 Series



## Product Features

- Wall mount fixture for architectural up light or down light application.
- ETL outdoor wet location listed. IP65 standard.
- Machined from solid billet 6061-T6 corrosion resistant aluminum.
- Swivel stem insert allows for precision adjustment during installation.
- Unique weep hole design in hood allows for either upward or downward facing installation with minimum light leak.
- US patented integral SORAA® heat sink.

**Integral SORAA® Heat Sink:** US patented Thermobuster™ provides extra heat dissipation that reduces the lamp junction temperature by 77°F(25°C). Enables even the highest wattage SORAA® lamps to be used in an enclosed fixture without sacrificing its performance or life expectancy.

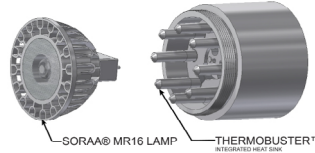

## Specification

**Materials:** Machined from billet 6061-T6 corrosion resistant aluminum with 304 stainless steel hardware. Available in 304/316 stainless steel or 360 brass upon request.

**Hood and Glare Shield:** 3 available hood options to suit any application. 3 optional glare shields (short, long, angled) to complement each hood choice. See page 2 for details.

**Light Source:** MR16 Halogen lamp or MR16 SORAA® LED lamp. Please refer to [SORAA MR16 GU5-3](#) for lamp selection.

**Voltage:** 120, 230V or 277V AC come with integral transformer.

**Wattage:**  
Max. 9W (x2) for SORAA MR16 lamp with Thermobuster.  
Max. 35W (x2) for halogen MR16.

**Lamp Base/Socket:** Standard bi-pin socket for GU5.3/G4/GX5.3/GY6.35/GZ4.

**Dimmability:** ELV dimming(consult factory for other types of dimming). Please refer to website for SORAA® MR16 dimmer compatibility. [SORAA MR16 dimmer compatibility.](#)

**Finish:** Polyester powder coat on all aluminum materials with RoHS compliant procedures. Anodized finish is available. Stainless steel and brass models are provided with brushed surface.

**Optical Accessories:** Accepts up to 3 accessory pieces (hexcel louver, optical lenses, dichroic color filters, etc.). Secured in place with metal snap ring.

**Mounting Accessory:** Utilizes 2x 8-32 UNC machine screws (provided) to attach to a standard octagon recessed back box (provided by others).

## Ordering Guide

EXAMPLE: ZX16i-WM2-SOi - A - GSL - 120V - 00917 - BK - LVR - CM5  
ZX16i-WM2 - B - GSL - 120V - 0 - BK - LVR - CM5

SERIES	MATERIAL	HOOD	OPTIONAL GLARE SHIELD	VOLTAGE	OPTIONAL LAMP	FINISH	OPTIONAL SELECT UP TO 3 OPTIC ACCESSORIES	OPTIONAL MOUNTING ACCESSORIES
ZX16i-WM2 HALOGEN	BLANK Aluminum(Standard) NBR Natural Brass NSS Natural Stainless Steel CU Natural Copper	A A-HOOD B B-HOOD	GSL GSA GSS	120V 230V 277V	0-NONE XXXXX SORAA® LAMP CODE (5 DIGIT SORAA CAT. NO*)	Standard BK Black Powder Coat BZ Bronze Powder Coat WT White Powder Coat Premium ABK Anodized Black ACL Anodized Clear CC Custom Powder Coat	LVR Hexcel Louver OSL Overall Spread Lens LSL Linear Spread Lens SOL Solite Soft Focus DF Dichroic Filter	See page 2 for quick reference, or "Accessories" link for detailed specification.
ZX16i-WM2-SOi SORAA®		C C-HOOD	CGSL CGSA CGSS					

\*SORAA® Lamp Selection: [SORAA MR16 GU5-3](#)

## Product Drawings

NOTE: Specification and dimensions subject to change without notice.

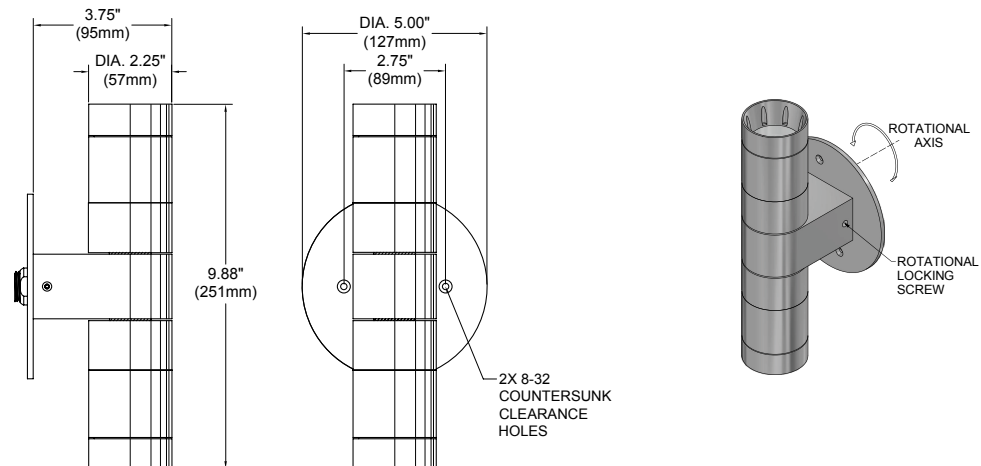

## Photometry & Energy Data (Per Head)

All SORAA® MR16 GU5.3 base lamps can be used in this fixture.  
Please refer to SORAA® website: [SORAA MR16 GU5-3](http://www.soraa.com/SORAA-MR16-GU5-3)

## Product Options & Accessories

### Hood Options

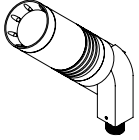

**A-HOOD**  
Versatile hood with 8 weep holes for water drainage. Regressed lens for glare control. Suggested for general use or when fixture is aimed in an up position.

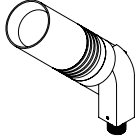

**B-HOOD**  
Similar to A hood but without weep holes. Regressed lens for glare control. Used in an interior or down light application.

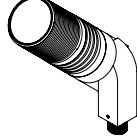

**C-HOOD**  
Flush hood with machined threading on the outside for attachment of C-style glare shield, cleverly designed with hidden drainage channels.

### Optional Glare Shield

For Use With A & B Hood  
Fastened With Set Screw

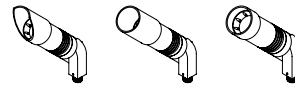
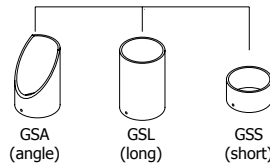

For Use With C Hood  
Fastened With Locking Ring

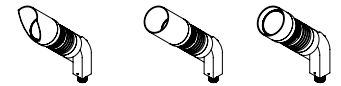
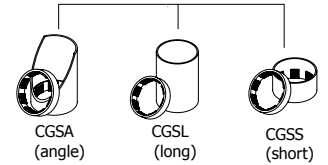

### Mounting Accessories

#### Canopy Plate:

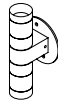

Fixture On CM5

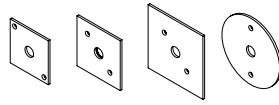

CM2 CM1 CM3 CM5

#### Surface Mount Box:



Fixture On CB5.1

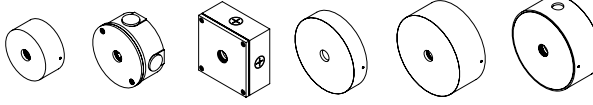

CB3.5 CB4.0 CB4.0-SQ CB5.1 CB5.5 CB5.5-K/O

#### Tree Mount:

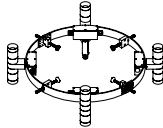

Fixture On TS-SO-26

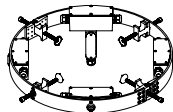

TS-SO

### Notes