

ZDL20-I Square

(includes former ZXL20i-CM-SQ model)

**IP65**

DOWNLIGHT | ZD20 Series | 3.00"

21-28W (2000-2700lm) | 120V-277V | HK LED, RGBW

FEATURES

- Powerful 3" square, integrated LED, line-voltage downlight for architectural outdoor applications.
- 21W, 28W integrated HK LED delivering 2000–2700 lumens. 2200–4000K CCT, including specialty RGBW option.
- Wet Location Listed, IP65 Standard.
- Machined from solid aircraft-grade (6061-T6), corrosion-resistant aluminum, then anodized and powder coated to create a highly durable, marine-grade finish. Also available in solid brass or stainless steel.
- Modular component design with configurable optical beam angles and accessory lenses.
- Includes CM3 4.75" canopy plate. Adjustable angled, long, and short glare shields, along with additional canopy and surface mount options, are available.
- Every fixture tested end of line for water tightness and light quality.



Line Voltage Downlight - Finned: ZDL20-IS1FB-ABR

SPECIFICATIONS

Materials

Solid billet 6061-T6 corrosion resistant aluminum with 304 stainless steel hardware.

Finish

Aluminum materials are first anodized and then powder coated for a robust, marine-grade finish. Stainless steel and brass models are provided with brushed surface.

Hood and Glare Shield

Non-weeping Hood Style. Set screw mounted Angled, Short, or Long Glare Shields. (See page 4 for details)

Voltage

120V-277V AC.

Wattage

21 or 28W HK LED delivers 2000–2700 lumens.

Light Engine

CRI 90 Standard. Available in CRI 80 or CRI 95 upon request. Standard CCT options are 2700K, 3000K, 3500K, 4000K. Specialty 2200K, 2400K, 2500K, and RGBW options available. Consult factory for specialty LED specification details.

Driver/Dimming

Onboard, Integrated LED Driver, Phase Control @120V, 0V-10V @120V-277V DALI or DMX control available, consult factory for details.

Optics

Narrow (16°), Medium (26°), Wide (40°), and Extra Wide (60°) beam spread options available. Accepts up to 3 optical accessories (hexcel louver, optical lenses, dichroic color filters, etc.) Secured in place with metal snap ring.

Mounting

Includes CM3 4.75" Canopy Plate and (2X) 8-32 UNC machine screws to attach to a standard 30 or 3R recessed back box (provided by others).

Listings

ETL Listed for Wet Location, IP65 Standard. RoHS Compliant.

ORDERING GUIDE

 EXAMPLE: **ZDL20-IS1FB-ABR-120V21W-22N-GSA-LVR-CM3-ABR**

MODEL	PHYSICAL OPTIONS				MATERIAL / FINISH			POWER				LIGHT			
ZDL20	IS1														
ZD20 Series 3.00" Square Downlight Integrated HK LED	IS1 Line Voltage, Square Light Integrated Driver				ABL Aluminum Black										
		STYLE	HOOD		ABR Aluminum Bronze		VOLTAGE		WATTAGE			CCT	OPTICS		
		S Standard	B B Style: No Weep Holes		AWH Aluminum White		120V 120V (Phase Control)		21W 21 Watt (2000lm)			22 2200K	N	Narrow (16°)	
		F Finned			AAC Aluminum Anodized Clear ¹		UNIV 120V-277V (0V-10V)		28W 28 Watt (2700lm)			24 2400K	M	Medium (26°)	
					NBR Natural Brass ¹				SPW Specialty ²			25 2500K	W	Wide (40°)	
					NCU Natural Copper ¹							27 2700K	E	Extra Wide (60°)	
					NSS Natural Stainless Steel ¹							30 3000K	CC	Custom Optic	
					CCC Custom Finish ¹							35 3500K			
												40 4000K			
												RG RGBW ²			

¹ For premium materials, please consult the factory for current lead times and pricing. A minimum order quantity of 10 units is required.

² For Specialty RG (RGBW LED), select SPW (Specialty) for Wattage. Consult factory for LED technical details before Specification or Order.

³ Mounts to 3R & 3O style junction boxes

OPTIONAL INSTALLED ACCESSORIES

GLARE SHIELD		OPTIC		MOUNTING (Most common listed, see Page 4 for additional options)	
GSA	B Glare Shield Angled	LVR	Hexcel Louver	CANOPY MOUNT	
GSL	B Glare Shield Long	OSL	Overall Spread Lens	CM3-XXX	4.75" Square Canopy Plate (Included) ³
GSS	B Glare Shield Short	LSL	Linear Spread Lens	SURFACE MOUNT	
		SOL	Solite Soft Focus	CB5.5-XXX	5.5" Round Surface Box
		DCF	Dichroic Filter		

- Consult Accessory Spec Sheet for desired option code.
- XXX represents color option.

ADDITIONAL ACCESSORIES (Not installed at time of order)

GLARE SHIELD ACCESSORIES

GSL-SQ-20-XXX	Square Glare Shield Long
GSA-SQ-20-XXX	Square Glare Shield Angled
GSS-SQ-20-XXX	Square Glare Shield Short

OPTIC ACCESSORIES

LVR-20	Hexcel Louver
OSL-20	Overall Spread Lens
LSL-20	Linear Spread Lens
SOL-20	Solite Soft Focus
DCF-20	Dichroic Filter
OPK-20	Optic Kit - Narrow, Medium, Wide, Extra Wide

PRODUCT DRAWINGS

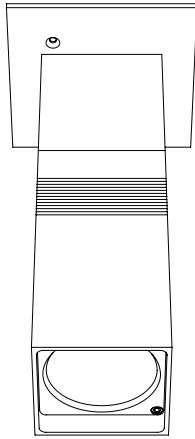

ZDL20-IS1FB
Finned

ZDL20-IS1FB

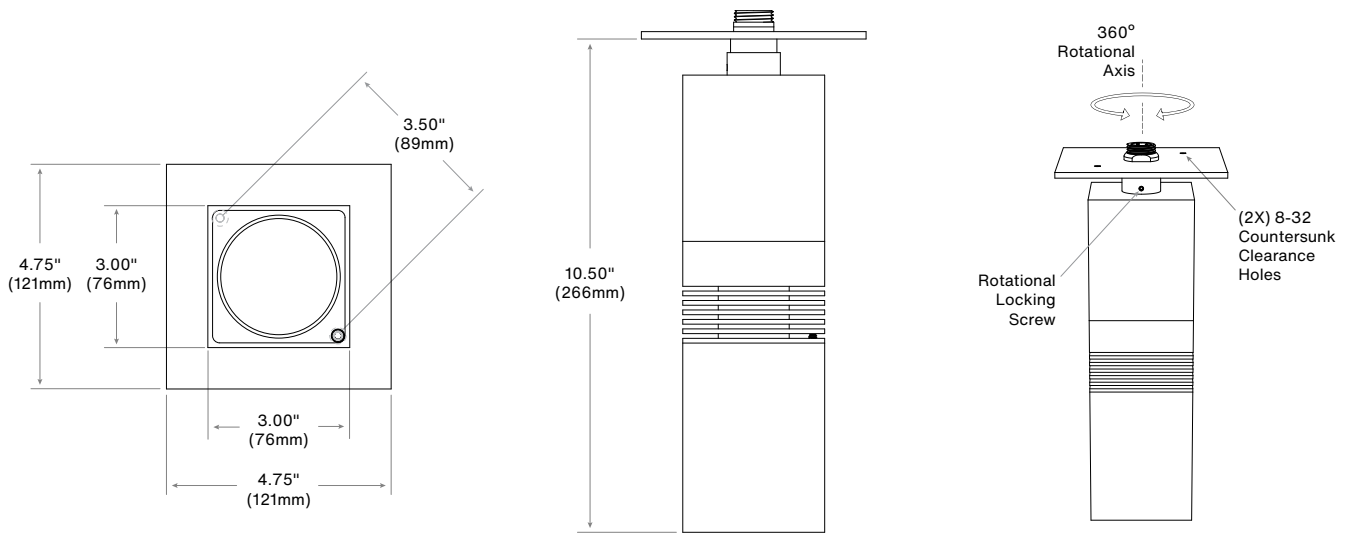

OPTIONS & ACCESSORIES

OPTIONAL GLARE SHIELD

For use with B Hood
Fastened with Set Screw

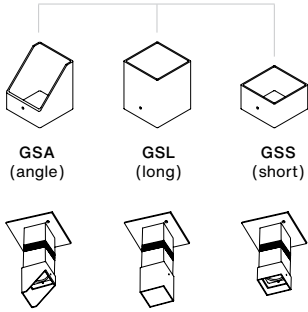

GSA (angle) GSL (long) GSS (short)

INCLUDED MOUNTING ACCESSORIES

Canopy Mount:



Fixture On CM3 CM3

OPTIONAL MOUNTING ACCESSORIES

Canopy Mount:

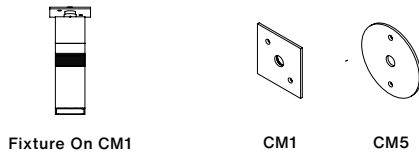

Fixture On CM1 CM1 CM5

Surface Mount Box:

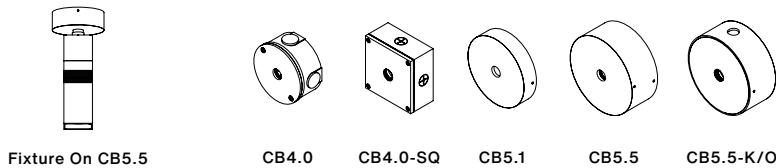

Fixture On CB5.5 CB4.0 CB4.0-SQ CB5.1 CB5.5 CB5.5-K/O

Notes:

PHOTOMETRY & ENERGY DATA

ZDL20-I (Narrow)

Input Power	28.2W
Color Temperature (CCT)	3000K
Color Rendering Index (Ra)	83
Beam Angle	16.1°
Max. Candlepower	17751cd
Delivered Lumens	2652lm
Efficacy	94lm/W

Polar Graph - Intensity

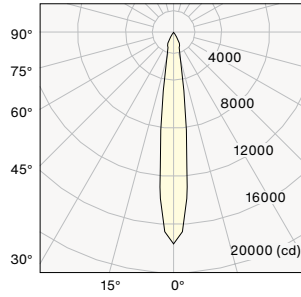

Cone of Light - Illuminance

Center Beam (fc)	Beam Diameter	Distance
4438	0.6'	2.0'
1109	1.1'	4.0'
493	1.7'	6.0'
277	2.3'	8.0'
178	2.8'	10.0'

1/2 Beam Angle: 16.1°

ZDL20-I (Medium)

Input Power	28.0W
Color Temperature (CCT)	3000K
Color Rendering Index (Ra)	83
Beam Angle	25.5°
Max. Candlepower	9513cd
Delivered Lumens	2702lm
Efficacy	97lm/W

Polar Graph - Intensity

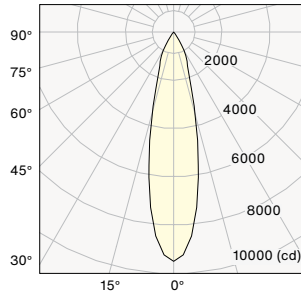

Cone of Light - Illuminance

Center Beam (fc)	Beam Diameter	Distance
2378	0.9'	2.0'
595	1.8'	4.0'
264	2.7'	6.0'
149	3.6'	8.0'
95	4.5'	10.0'

1/2 Beam Angle: 25.5°

ZDL20-I (Wide)

Input Power	28.0W
Color Temperature (CCT)	3000K
Color Rendering Index (Ra)	83
Beam Angle	44.2°
Max. Candlepower	4285cd
Delivered Lumens	2220lm
Efficacy	82lm/W

Polar Graph - Intensity

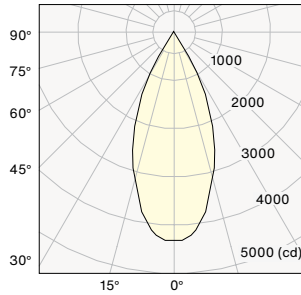

Cone of Light - Illuminance

Center Beam (fc)	Beam Diameter	Distance
1071	2.3'	2.0'
268	4.6'	4.0'
119	6.9'	6.0'
67	9.3'	8.0'
43	11.6'	10.0'

1/2 Beam Angle: 44.2°

ZDL20-I (Extra Wide)

Input Power	29.0W
Color Temperature (CCT)	3000K
Color Rendering Index (Ra)	83
Beam Angle	60.1°
Max. Candlepower	2926cd
Delivered Lumens	2667lm
Efficacy	92lm/W

Polar Graph - Intensity

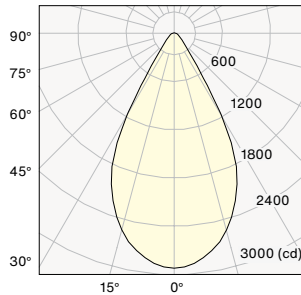

Cone of Light - Illuminance

Center Beam (fc)	Beam Diameter	Distance
731	2.3'	2.0'
183	4.6'	4.0'
81	6.9'	6.0'
46	9.3'	8.0'
29	11.6'	10.0'

1/2 Beam Angle: 60.1°

WATTAGE MULTIPLIER

Type	Wattage	Multiplier
N21	21 Watt	0.71
N28	28 Watt	1.00

CCT MULTIPLIER

Color Temp.	Multiplier
2700k	0.97
3000k	1.00
4000k	1.05
RGBW	N/A